

FLÄKT WOODS LIMITED

FANS IN FIRE SAFETY

**SMOKE CONTROL
BY
PRESSURISATION**

By: J.A. WILD, C.ENG; F.I.MECH.E.

A SIMPLIFIED APPROACH TO PRESSURISATION CALCULATIONS

© Copyright 2000 Fläkt Woods Limited England.

AIRTREND Limited
Predstavništvo u Beogradu
Kumanovska 14, 11000 Beograd
Tel: 011/3836886, 3085740
Faks: 011/3444113
e-mail: gobrid@eunet.rs
web: www.airtrend.rs



This document has been produced as a general guide and its contents should not be construed as any representation on our part as to the quality or fitness of our products for any particular purpose, nor as providing advice on the design of fire and smoke control systems. You are recommended to consult your professional advisers on matters relating to the design and installation of any such systems.

SMOKE CONTROL BY PRESSURISATION

SUMMARY

Woods Technical Paper - WTP41 - 1998 Edition - traces the development of Pressurisation Systems in the control of Fire Smoke In Buildings.

Based on the revised British Standard - BS5588: Part 4: 1998, Code of practice for smoke control using pressure differentials it outlines the requirement of both the various systems detailed in this Code Of Practice and the fans required to power these systems.

This Paper supports WTP41 and is intended to assist engineers in designing pressurisation systems. It examines in detail the fan engineering problems raised by the new Code, and suggests a simplified method for quickly estimating the air volume rates required - useful at the early stage of the project.

1.0 INTRODUCTION

BS5588: Part 4: 1998, brought together the pressurisation requirement of earlier Codes Of Practice, (BS5588 Part 4: 1978 & BS5588 Part 5: 1991) and added three additional scenarios - making a total of five classes of pressurisation systems.

These five classes of system are outlined in Table 1 below - detailed in Figs. 1 to 5.

System Class	Area of Use	Requirement of System
A	Residential, sheltered housing & Buildings with three door protection.	To maintain pressure of 50Pa when all doors are closed To maintain velocity of 0.75m/s through open Fire Floor Door Door Status - See Fig 1
B	Protection of firefighting shafts	To maintain pressure at 50Pa when all doors are closed To maintain velocity of 2.0m/s through open Fire Floor Door Door Status - See Fig 2
C	Commercial premises (using simultaneous evacuation)	To maintain pressure of 50Pa with all doors closed To maintain velocity of 0.75m/s through open Fire Floor Door To maintain pressure of 10Pa with final Exit Door Open Door Status - See Fig. 3
D	Hotels, hostels and institutional-type buildings, excluding those in Class A	As above (C) Door Status - See Fig. 4
E	Buildings using phased evacuation	As above (C) Door Status - See Fig. 5

TABLE 1 - CLASS OF SYSTEMS

SYSTEM CLASSES

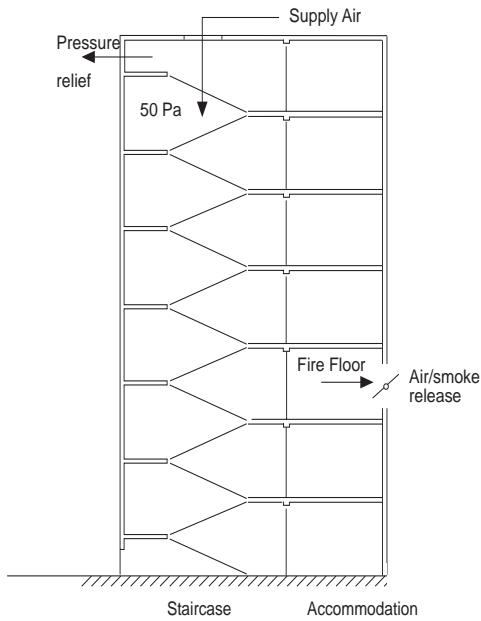

Mode 1 - Pressure criterion all doors closed

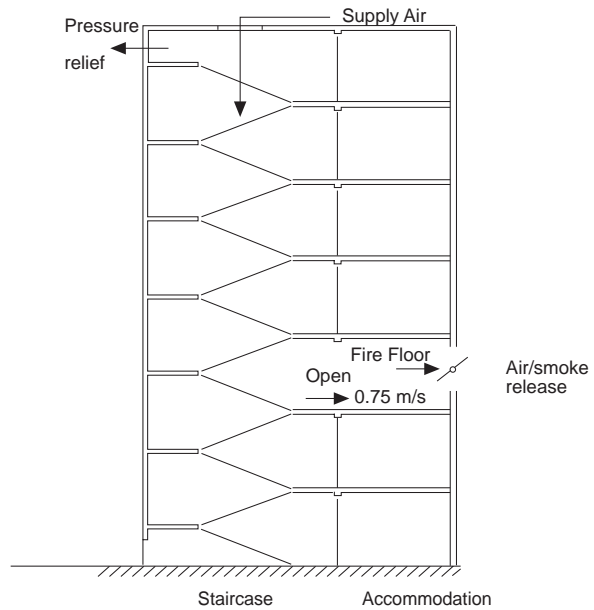

Mode 2 - Velocity Criterion

Fig 1 Class A System - Staircase only

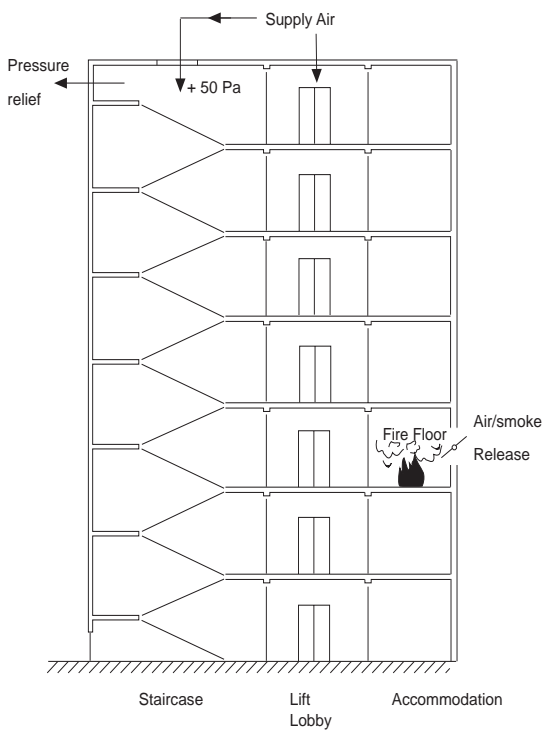

Mode 1 - Pressure criterion all doors closed

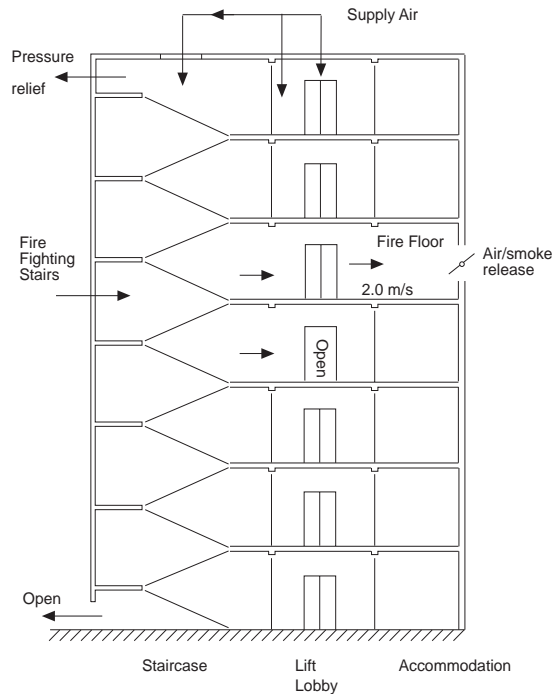

Mode 3 Fire Fighting - Velocity Criterion

Fig 2 Class B System - Fire Fighting Stairs and Lift

SYSTEM CLASSES

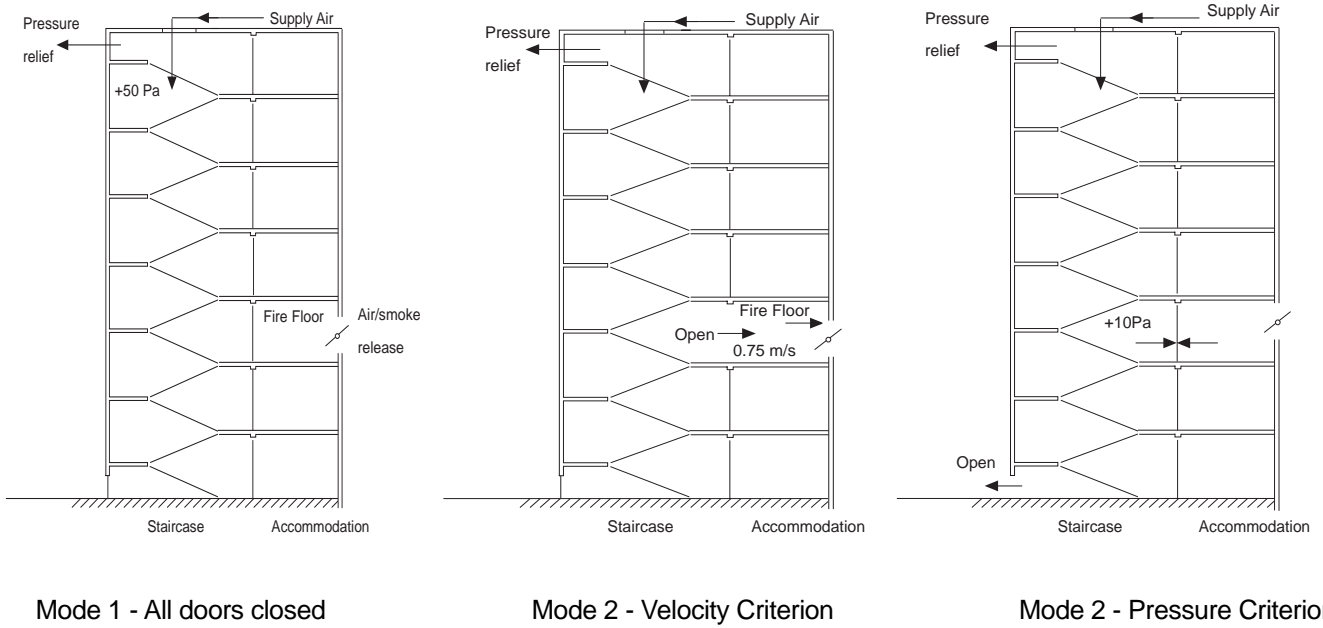

Fig 3 Class C System - Staircase only pressurised

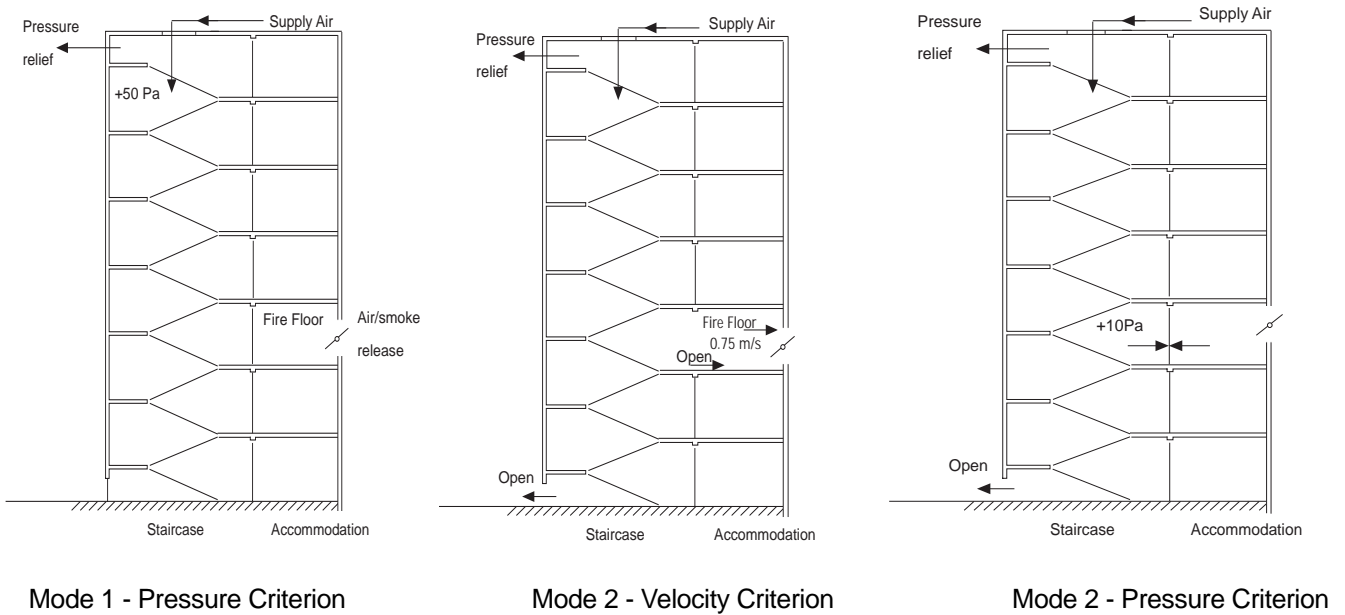
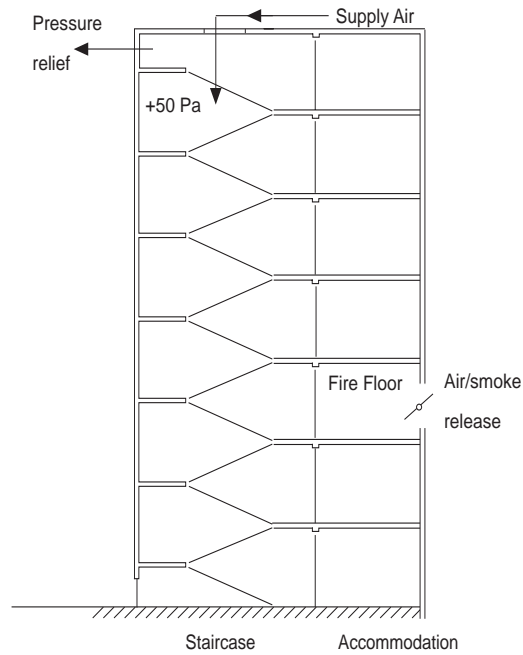
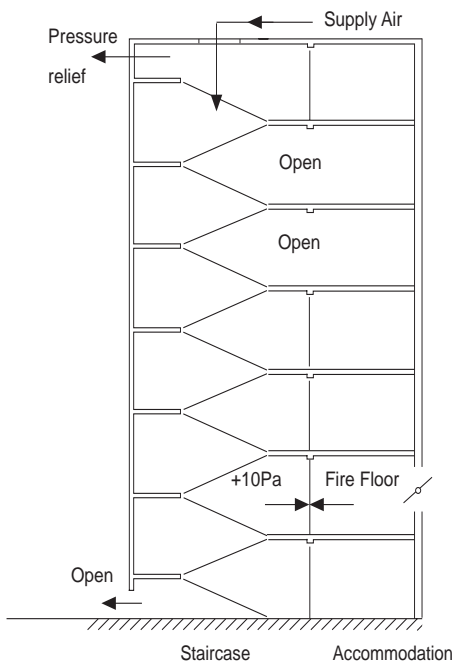

Fig 4 Class D System - Staircase only pressurised

SYSTEM CLASSES



Mode 1 - Pressure Criterion



Mode 2 - Pressure Criterion

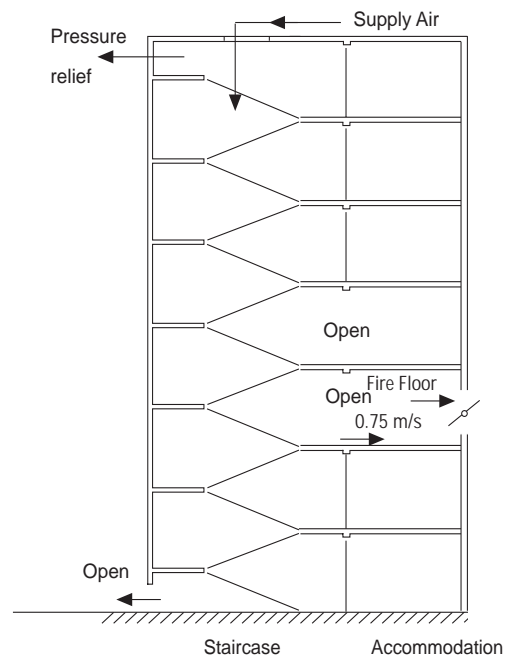

Mode 2 - Velocity Criterion

Fig 5 - Class E Systems - Staircase only pressurised

The requirements of these Fire Pressurisation System classes produce a wide range of variation in the leakage paths from the pressurised spaces. Fortunately, a number of these leakage paths are common to more than one system, and hence a degree of standardisation becomes possible. These common features are listed below:-

1. ALL CLASSES of system have a PRESSURE CRITERION of **50Pa** with ALL DOORS CLOSED (Mode 1)
2. CLASS A SYSTEMS - have a velocity criterion of **0.75m/s** through the OPEN FIRE DOOR (Mode 2) with ALL other DOORS CLOSED.
3. CLASS B SYSTEMS - have a VELOCITY CRITERION of **2.0m/s** through the OPEN FIRE FLOOR DOOR (Mode 3) with the FINAL EXIT DOOR OPEN

CLASS B SYSTEMS - have a PRESSURE CRITERION of **50Pa** in the FIRE FIGHTING LIFT at all times.

4. CLASS C SYSTEMS - have a PRESSURE CRITERION of **10Pa** with the FINAL EXIT DOOR OPEN, AND a VELOCITY CRITERION of **0.75m/s** through the OPEN FIRE FLOOR DOOR with ALL OTHER DOORS CLOSED (Mode 2).
5. CLASS D SYSTEMS - have a PRESSURE CRITERION of **10Pa** AND a VELOCITY CRITERION of **0.75 m/s** through the OPEN FIRE FLOOR DOOR with the FINAL EXIT DOOR OPEN (Mode 2)
6. CLASS E SYSTEMS - have a PRESSURE CRITERION of **10Pa** with the FINAL EXIT and TWO NON FIRE FLOOR DOORS OPEN, AND a VELOCITY CRITERION of **0.75 m/s** through the OPEN FIRE FLOOR DOOR with the FINAL EXIT and ONE NON FIRE FLOOR DOOR OPEN
7. LIFT SHAFTS - have a top vent aperture of 0.1m^2 in addition to the lift doors.

2.0 BASIC PRINCIPLES & FAN ENGINEERING

The two BASIC PRINCIPLES which control the design and ultimately the satisfactory functioning of a PRESSURISATION SYSTEM for Smoke Control were defined by J.H. Klote as being:-

- (1) That airflow can control smoke movement if the average VELOCITY is of sufficient magnitude (VELOCITY CRITERION)
- (2) That PRESSURE differences across barriers can act to control smoke movement (PRESSURE CRITERION)

The VELOCITY CRITERION usually, but not always, establishes both the air quantity requirement and the airflow patterns for the system, where NATURAL EXHAUST from the fire floor is used.

2.1 VELOCITY CRITERION

The air quantity required to maintain an air velocity through the open fire floor door can be calculated by:

$$Q = A \times V \text{ ----- EQUATION 1}$$

where

Q	=	volume of air through open door	(m ³ /s)
A	=	area of single leaf door	(m ²)
V	=	air velocity specified by Code Of Practice	(m/s)

The two air velocities specified in BS5588: Part 4: 1998 are:-

Means of Escape	-	Systems A.C.E.D	-	0.75m/s
Fire Fighting	-	System B	-	2.00m/s

This provides the quantity of air onto the fire floor.

2.1.1 EXHAUST VENT FROM FIRE FLOOR

To maintain these VELOCITY CRITERION it is necessary to provide a low resistance path for the air to leave the building via. the fire floor.

This can be achieved by either NATURAL or POWERED venting.

Where direct NATURAL venting is used the area of the vent or opening is given by:

$$A = \frac{Q}{2.5} \text{ ----- EQUATION 2}$$

Where NATURAL venting, using a common duct connecting several floors is necessary, the area "A" of the ducting is given by:

$$A = \frac{Q}{2.0} \text{ ----- EQUATION 3}$$

A	=	area of ducting (m ²)
Q	=	volume of airflow through open fire floor door (m ³ /s)

Where POWERED venting is used the exhaust fan must be sized to extract the volume of air flowing through the open fire floor door, against the calculated resistance of the exhaust ductwork system.

In addition, exhaust fans - both run and standby - are required to survive the following **TEMPERATURE/TIME** specification.

SPRINKLERED BUILDING	-	300°C for 2 hours
UN-SPRINKLERED BUILDING	-	600°C for 2 hours

The quantity of air required from the SUPPLY fan is arrived at by adding to this airflow through the open fire door, the air quantity that will be escaping through other leakage areas in the pressurised space. These are operating **Mode 2** (Escape) and **Mode 3** (Fire Fighting) of the system.

2.2 PRESSURE CRITERION

The quantity of air required to maintain the PRESSURE CRITERION can be calculated by:-

$$Q = 0.83 A_E p^{0.5} \text{ ----- EQUATION 4}$$

where

Q	=	volume flow of air required	(m ³ /s)	
A _E	=	effective leakage area	(m ²)	- (See Table 2)
p	=	pressure specified by Code Of Practice	(Pa)	

This will deal with the **known** leakage from the pressurised space. The unknown leakage's are allowed for by adding 50% - recommended in the Code Of Practice - to the resulting air quantity. Hence Equation 4 becomes:-

$$Q = 0.83 A_E p^{0.5} \times 1.50 \text{ ----- EQUATION 5}$$

There are two pressure criterion specified in BS5588: Part 4: 1998

All Doors **Closed** - 50Pa
 Certain Doors **Open** - 10Pa

Hence to make this equation work we need to establish A_E - the effective leakage area from the pressurised space. There are three possible open/door configurations.

1. For single openings

$$A_E = A_1 \text{ ----- EQUATION 6}$$

2. For several openings in parallel

$$A_E = A_1 + A_2 + A_3 + A_4 \text{ ----- EQUATION 7}$$

3. For several openings in series

$$A_E = \left[\frac{1}{A_1^2} + \frac{1}{A_2^2} + \frac{1}{A_3^2} + \frac{1}{A_4^2} \right]^{-0.5} \text{ ----- EQUATION 8}$$

These open/door configurations are discussed in more detail in WTP41

2.2.1 PRESSURE RELIEF DAMPER

Generally the air volume required to achieve the **VELOCITY CRITERION** or **PRESSURE CRITERION** when doors are **OPEN** exceed that necessary to establish the **PRESSURE CRITERION** when all doors are **CLOSED (DETECTION PHASE)**.

To prevent the build-up of excessive pressures in the pressurised space (escape routes) when all doors are **CLOSED** (+ 60Pa in BS5588:Part 4:1998), a pressure relief damper is required between the pressurised space and an area of zero pressure (usually outside the building).

The area of this pressure relief damper can be calculated using the following expression

$$A = \frac{Q}{0.83 \times p^{0.5}} \text{----- EQUATION 9}$$

- A = area of pressure relief (m²)
 Q = volume flow of air to be released (m³/s)
 p = maximum allowable pressure (60Pa)

- NOTES:** 1. Designers often use 50Pa for safety
 2. Equation 9 is a transposition of Equation 4

2.3 LEAKAGE POINTS

The various leakage points which occur in a pressurisation system are discussed below:-

2.3.1 Closed Doors

The effective leakage area from the system when all the doors are closed can be established by using the values in TABLE 2 with equations (4) (5) and (6). These values only apply to the door **types** and **sizes** shown.

This is operating **Mode 1** of the system.

TYPE OF CLOSED DOORS AND OTHER LEAKAGE ROUTES	SIZE	CRACK LENGTH (m)	LEAKAGE AREA (m ²)
Single leaf in frame opening into pressurised space	2m x 0.8m	5.6	0.01
Single leaf in frame opening outwards	2m x 0.8m	5.6	0.02
Double leaf with or without central rebate	2m x 1.6m	9.2	0.03
Lift Door	2m High x 1m Wide	8.0	0.06
Lift Top Vent	-	-	0.1
Open Lift Door Class B Systems (with lift cage at that floor)	2m High x 1m Wide	6.0 (around lift cage)	0.15
Open Door Single Leaf	2m x 0.8m	-	1.60

TABLE 2 - TYPICAL LEAKAGE AREAS AROUND CLOSED DOORS, OPEN DOORS, AND OTHER LEAKAGE ROUTES.

2.3.2 Open Final Exit door

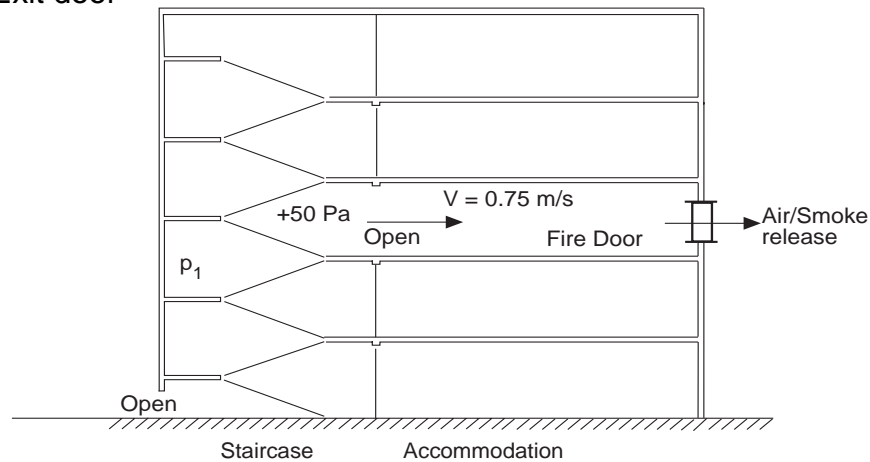

FIG. 6 - AIRFLOW THROUGH OPEN EXIT DOOR

The volume of air that will leak through the FINAL EXIT DOOR will be determined by two factors:-

- 1) The area of the door opening m^2
- 2) The residue pressure in the stairwell (p_1) Pa

The residue pressure in the stairwell (p_1) is that required to produce the air velocity, demanded by the Code Of Practice, through the fire floor to outside the building. Hence (p_1) is determined by the number of openings through which the air passes and the air velocity.

For the example above.

Area of Fire Floor Door A_1	=	1.6m^2
Door Velocity V	=	0.75m/s
Volume flow of Air - $A \times V$	=	$1.20\text{m}^3/\text{s}$
Area of Air/Smoke Release Vent = $Q/2.5 = A_2$	=	0.48m^2

To calculate residue pressure (p_1) (using Equation (4) and (8))

$$A_E = \left[\frac{1}{A_1^2} + \frac{1}{A_2^2} \right]^{-0.5} = \left[\frac{1}{1.6^2} + \frac{1}{0.48^2} \right]^{-0.5} = \underline{0.458\text{m}^2}$$

$$p_1 = \left[\frac{Q}{0.83 \times A_E} \right]^2 = \left[\frac{1.2}{0.83 \times 0.458} \right]^2 = \frac{9.96\text{Pa}}{\text{(Say } 10\text{Pa)}}$$

To calculate volume airflow through open final exit door

$$Q = 0.83 A p_1^{0.5} = 0.83 \times 1.6 \times 10^{0.5} = \underline{4.19\text{m}^3/\text{s}}$$

Table 3 has been prepared using equations 4 & 9 in this way. It shows the air leakage through open exit doors of different sizes (m^2), under various door/vent systems for the two door velocities (0.75m/s Escape) and (2.0m/s Fire Fighting) specified in BS5588: Part 4: 1998.

Table 3 can be used to quickly estimate this air leakage for this component.

CATEGORY	SYSTEM	RESIDE STAIRCASE PRESSURE (Pa)	AREA OF OPEN EXIT m ²				
			1.00	1.60	2.00	2.50	3.00
Escape Only	1 Door + Vent	9.96	2.62	4.19	5.23	6.55	7.86
	2 Doors + Vent	10.80	2.72	4.36	5.45	6.82	8.18
	3 Doors + Vent	11.56	2.82	4.51	5.64	7.05	8.47
Fire Fighting	1 Door + Vent	14.80	3.19	5.10	6.38	7.98	9.58
	2 Doors + Vent	20.00	3.71	5.93	7.42	9.28	11.13
	3 Doors + Vent	26.40	4.26	6.82	8.53	10.66	12.79

TABLE 3 - AIRFLOW LEAKAGE THROUGH OPEN FINAL EXIT DOOR

Powered Exhaust

The air leakage volumes in TABLE 3 assume a natural EXIT VENT from the fire room sized as specified in BS5588: Part 4: 1998. (i.e. $A = Q/2.5$) - See also Paragraph 2.1.1.

When powered exhaust from the fire room is being used, the high temperature exhaust fan will be selected to deal with what would have been the exit vent resistance. Under these circumstances the air leakage volume through the final exit door will be for our purposes, equal to the air volume through the fire floor door.

The effect, therefore, of using Powered Exhaust will be to reduce the volume required from the pressurisation supply fan, and could result in the OPEN DOOR - PRESSURE CRITERION STATUS determining the size of the supply air fan.

2.3.3 Leakage Through Open Doors On Non-Fire Floors

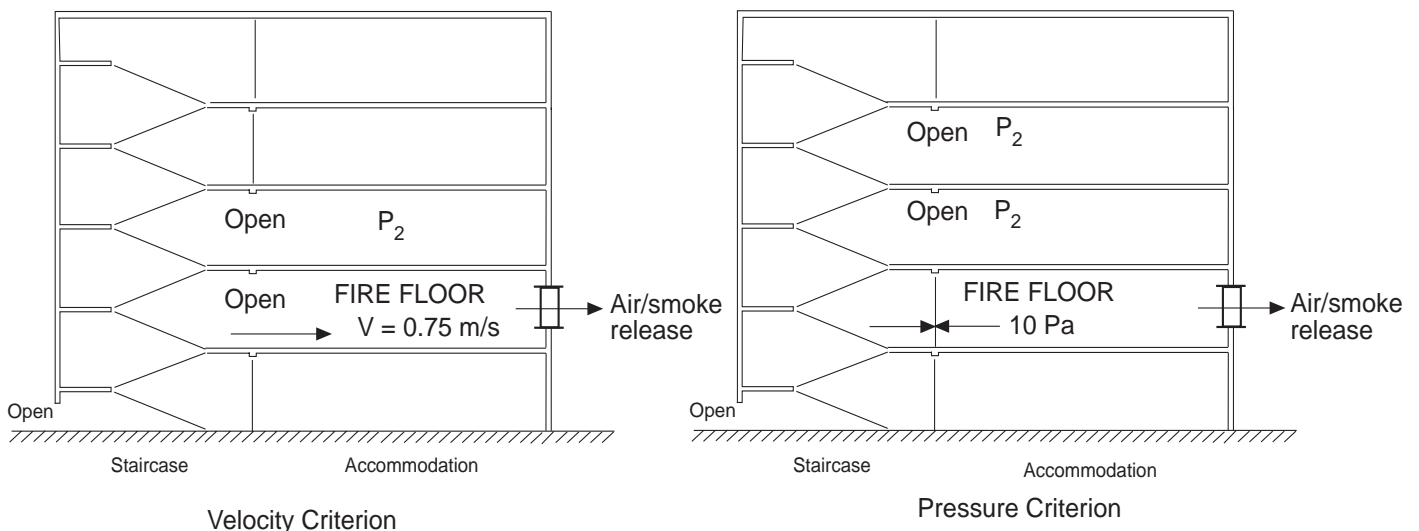

FIG. 7 - AIRFLOW LEAKAGE THROUGH OPEN NON-FIRE FLOOR DOORS

This situation only arises on CLASS E Systems - Fig. 7 above, hence when $P = 10\text{Pa}(\text{max.})$ and $v = 0.75\text{m/s}$.

Table D3 - BS 5588: Part 4: 1998 provides information on expected leakage through various building structures. Assuming average leakage through floors, and loose walls, in rooms 3m high, the airflow leakage for rooms of increasing area can be estimated using Equation 4. TABLE 4, details the results, and can be used to estimate this leakage component.

ROOM AREA (m ²)	ROOM PRESSURE (P ²) Pa	ROOM LEAKAGE AREA A _E m ²	AIRFLOW LEAKAGE m ³ /s
Less than 50m ²	10	0.034	0.09
100m ²	10	0.0524	0.137
400m ²	10	0.1256	0.33
900m ²	10	0.2186	0.574
1600m ²	10	0.3344	0.877

TABLE 4 - AIRFLOW LEAKAGE THROUGH NON-FIRE FLOOR ROOMS

Of course, air leakage through walls and floors can be very variable. The parameters used in compiling Table 4 have been selected to be on the safe side. No allowance has been made for leakage around windows - double glazing is assumed.

To be absolutely safe - one could apply the + 50% rule to these leakage values discussed in Paragraph 2.2, but this is left to the designers discretion.

2.3.4 Lift Shafts

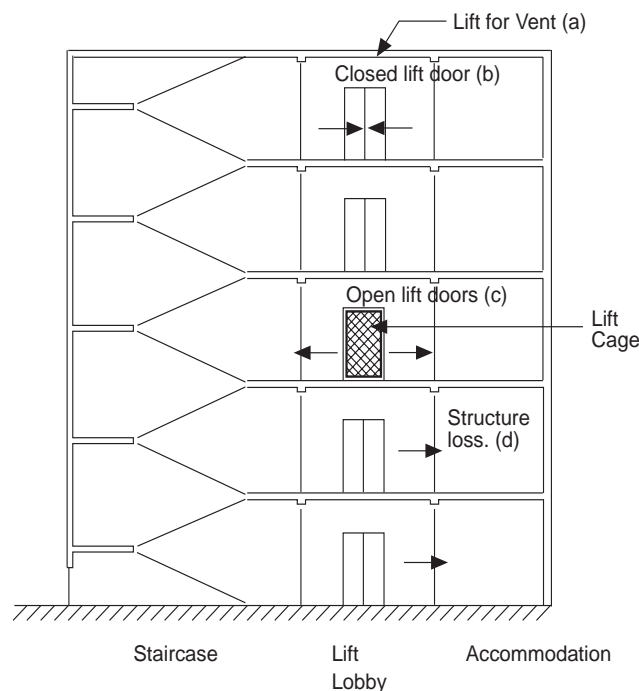

FIG. 8 - LEAKAGE PATHS FROM LIFT SHAFTS

There are four possible leakage paths from and into lift shafts, as shown on Fig. 8, and the lift shaft itself can be pressurised (Class B Systems) or un-pressurised (Class A, C, D & E System).

(a) Lift Top Vent

There is usually a vent of 0.1m² at the top of each lift shaft to compensate for the movements of the lift cage and provide a degree of smoke clearance from the un-pressurised lift shaft. (This leakage area of 0.1m² has been included in TABLE 2 Page 10 & n17 for convenience).

With Class A,C, D and E Systems, where the lift shaft remains un-pressurised, this lift top vent will usually be in SERIES with the lift doors. Therefore, A_E , the effective area of this arrangement can be determined using Equation 8. However, A_E calculated in this way will usually be less than the smallest area in the series - always the 0.1m² vent. So for convenience, this value could be used in the estimation. With CLASS B - Fire Fighting Systems - where the lift shaft itself is pressurised, there will be no airflow across the lift/lobby doors !. Hence the lift top vent will be the major leakage point from the lift shaft. To eliminate this leakage point, on CLASS B Systems, some authorities have allowed a Pressure Relief Damper to be fitted set to open at 50Pa. This reduces the volume of air required to the lift shaft.

(b) Closed Lift Doors

The leakage area (A_E) around closed lift doors can be assessed from Table 2. and the airflow leakage calculated using Equations (4) and (8).

(c) Open Lift Doors

The firemans lift has been used to bring men and equipment to the floor immediately below the fire floor. The lift cage will be stopped at that floor with the draft door open.

The leakage area (A_E) around open lift doors (Class B System) will be the perimeter of the door times the gap between the door frame and lift cage (say 6,000mm x 25mm). Hence for a lift door of 2m high x 1m wide

$$A_E = 6\text{m} \times 0.025\text{m} = 0.15\text{m}^2/\text{s}$$

(This leakage area of 0.15m² has been included in TABLE 2 on Pages 10 and 17 for convenience)

The airflow leakage into the lift lobby can now be calculated using Equation (4)

(d) Lift Shaft Walls

Lift shaft walls are unlikely to be plastered and finished on their internal surfaces, however they could be so finished, and hence sealed on their external surfaces.

In addition, one face of the lift shaft will house the lift doors which may open onto the pressurised lobby. Other faces of the lift shaft could abut pressurised spaces. In short, not all lift shafts will have leakage - and not all lift shafts will have leakage on all surfaces. Adding +50% to the volume of air being supplied to the lift shaft may be sufficient to deal with this leakage path, during the initial estimation of fan volume requirement.

TABLE 5 provides a method of allowing for lift shaft structural leakage.

The air leakage values (m³/s) have been calculated using Equation 4. They are based on the assumed leakage through three sides of a 2m x 2m lift shaft with a leakage ratio of 0.84 x 10⁻³ from Table D3 on page 52 of BS5588: Part 4: 1998, pressurised to 50Pa

LIFT SHAFT HEIGHT (m)	LIFT SHAFT (m)	LIFT SHAFT PRESSURE (Pa)	LEAKAGE (m ²)	AIRFLOW LEAKAGE (m ² /s)
Less than 12	2 x 2	50	0.06	0.35m ³ /s
18			0.09	0.53m ³ /s
24			0.12	0.70m ³ /s
30			0.15	0.88m ³ /s

TABLE 5 - AIRFLOW LEAKAGE THROUGH PRESSURISED LIFT SHAFT WALLS

We now we have the tools to enable an assessment of the air quantity requirement of a particular system be made, and hence the size of both the supply fan and ductwork. These EQUATIONS and TABLES developed in this paper are, for convenience summarised on the next page.

SUMMARY OF EQUATIONS

EQUATION 1 To calculate air volume required to maintain VELOCITY CRITERION

$Q = A \times V$	Q	=	air volume required	- m ³ /s
	A	=	area of single left door	- m ²
	V	=	specified code velocity	- m/s

EQUATION 2/3 To calculate area of Air/Smoke Release Vents or ducting from fire floor

Equation 2	-	$A_{VENT} = \frac{Q}{2.5} \frac{A_{VENT}}{A_{DUCT}}$	A_{VENT}	=	area of exhaust vent	- m ²
			A_{DUCT}	=	area of exhaust ducting	- m ²

Equation 3	-	$A_{DUCT} = \frac{Q}{2.0}$	Q	=	volume of exhaust air	- m ³ /s
------------	---	----------------------------	-----	---	-----------------------	---------------------

EQUATION 4 To calculate air volume required to maintain PRESSURE CRITERION

$Q = 0.83A_E p^{0.5}$	Q	=	air volume required	- m ³ /s
	A_E	=	effective leakage area	- m ²
	p	=	specified code pressure	- pa

EQUATION 5 To calculate air volume required to maintain PRESSURE CRITERION
- with allowance for unidentified leakage.

$Q = 0.83AE p^{0.5} \times 1.5$	Q	=	air volume required	- m ³ /s
	A_E	=	effective leakage required	- m ²
	p	=	specified code pressure	- Pa

EQUATIONS 6 - 8 To access effective area (A_E) of opening/doors in PARALLEL and SERIES

Equation 6	-	Single Openings	=	$A_E = A_1$
Equation 7	-	Parallel Openings	=	$A_E = A_1 + A_2 + A_3$
Equation 8	-	Series Openings	=	$A_E = \left[\frac{1}{A_1^2} + \frac{1}{A_2^2} + \frac{1}{A_3^2} \right]^{-0.5}$

EQUATION 9 To calculate area of PRESSURE RELIEF DAMPER

$A = \frac{Q}{0.83 \times p^{0.5}}$	A	=	area of pressure relief	- m ²
	Q	=	air volume to be wasted	- m ³ /s
	p	=	maximum pressure	- Pa

EQUATION 10 To calculate residue PRESSURE in spaces

$p = \left[\frac{Q}{0.83A_E} \right]^2$	p	=	residue pressure	- Pa
	Q	=	air volume entering space	- m ³ /s
	A_E	=	effective leakage area from space	- m ²

SUMMARY OF TABLES

TABLE 2 - TYPICAL LEAKAGE AREAS AROUND CLOSED DOORS, OPEN DOORS AND OTHER LEAKAGE ROUTES

TYPE OF CLOSED DOOR AND OTHER LEAKAGE ROUTES	SIZE	CRACK LENGTH (m)	LEAKAGE AREA (m)
Single Leaf in Frame Opening into Pressurised Space	2m x 800mm	5.6	0.01
Single Leaf in Frame Opening Outwards	2m x 800mm	5.6	0.02
Double Leaf with or without Central Rebate	2m x 1.6m	9.2	0.03
Lift Door	2m High x 1m Wide	8.0	0.06
Lift Top Vent	-	-	0.1
Open Lift Door Class B Systems	2m High x 1m Wide	6.0	0.15
Open Door Single Leaf	2m x 0.8m	-	1.60

TABLE 3 - AIRFLOW LEAKAGE THROUGH OPEN FINAL EXIT FLOOR

CATEGORY	SYSTEM	RESIDE STAIRCASE PRESSURE (Pa)	AREA OF OPEN EXIT m ²				
			1.00	1.60	2.00	2.50	3.00
			AIR LEAKAGE m ³ /s				
Escape Only	1 Door + Vent	9.96	2.62	4.19	5.23	6.55	7.86
	2 Doors + Vent	10.80	2.72	4.36	5.45	6.82	8.18
	3 Doors + Vent	11.56	2.82	4.51	5.64	7.05	8.47
Fire Fighting	1 Door + Vent	14.80	3.19	5.10	6.38	7.98	9.58
	2 Doors + Vent	20.00	3.71	5.93	7.42	9.28	11.13
	3 Doors + Vent	26.40	4.26	6.82	8.53	10.66	12.79

TABLE 4 - AIRFLOW LEAKAGE THROUGH NONE FIRE FLOOR DOORS

ROOM AREA (m ²)	ROOM PRESSURE (p ²) PRESSURE (Pa)	ROOM LEAKAGE AREA (m ²)	AIRFLOW LEAKAGE (m ³ /s)
Less than 50m ²	10	0.034	0.09
100m ²	10	0.0524	0.137
400m ²	10	0.1256	0.33
900m ²	10	0.2186	0.574
1600m ²	10	0.3344	0.877

TABLE 5 - AIRFLOW LEAKAGE THROUGH PRESSURISED LIFT SHAFT WALLS

LIFT SHAFT HEIGHT (m)	LIFT SHAFT (m)	LIFT SHAFT PRESSURE (Pa)	LEAKAGE (m ²)	AIRFLOW LEAKAGE (m ² /s)
Less than 12	2 x 2	50	0.06	0.35m ³ /s
18			0.09	0.53m ³ /s
24			0.12	0.70m ³ /s
30			0.15	0.88m ³ /s

3. WORKED EXAMPLES

A complete and detailed calculation procedure with worked examples is outlined in BS5588: Part 4: 1998. Designers should follow this approach when seeking approval for their schemes.

The examples in this paper utilise the “tools” described in Paragraph 2. This much simpler method developed from procedures created and used by Mr. C. H. Moss is very useful for the initial sizing and selection of the supply air fans. It will always tend to over-estimate the air supply requirements (See WTP41).

The examples cover each of the five pressurisation system classes detailed in BS5588: Part 4: 1998 and include between them, all the system elements and leakage paths discussed in Paragraphs 1 & 2. They assumed NATURAL EXHAUST from the FIRE FLOOR. For convenience and clarity the EQUATIONS and TABLES used in these examples are referenced in the Right-hand Column of each page.

The Code Of Practice suggests that an allowance is added to the air quantity requirements calculated to cover any airflow leakage of ductwork.

Sheet metal Ductwork	-	+ 15%
Builders Work Ducts	-	+ 25%

In this paper these allowances are left to the discretion of the Designers.

3.1 CLASS A SYSTEM - STAIRCASE ONLY PRESSURISED

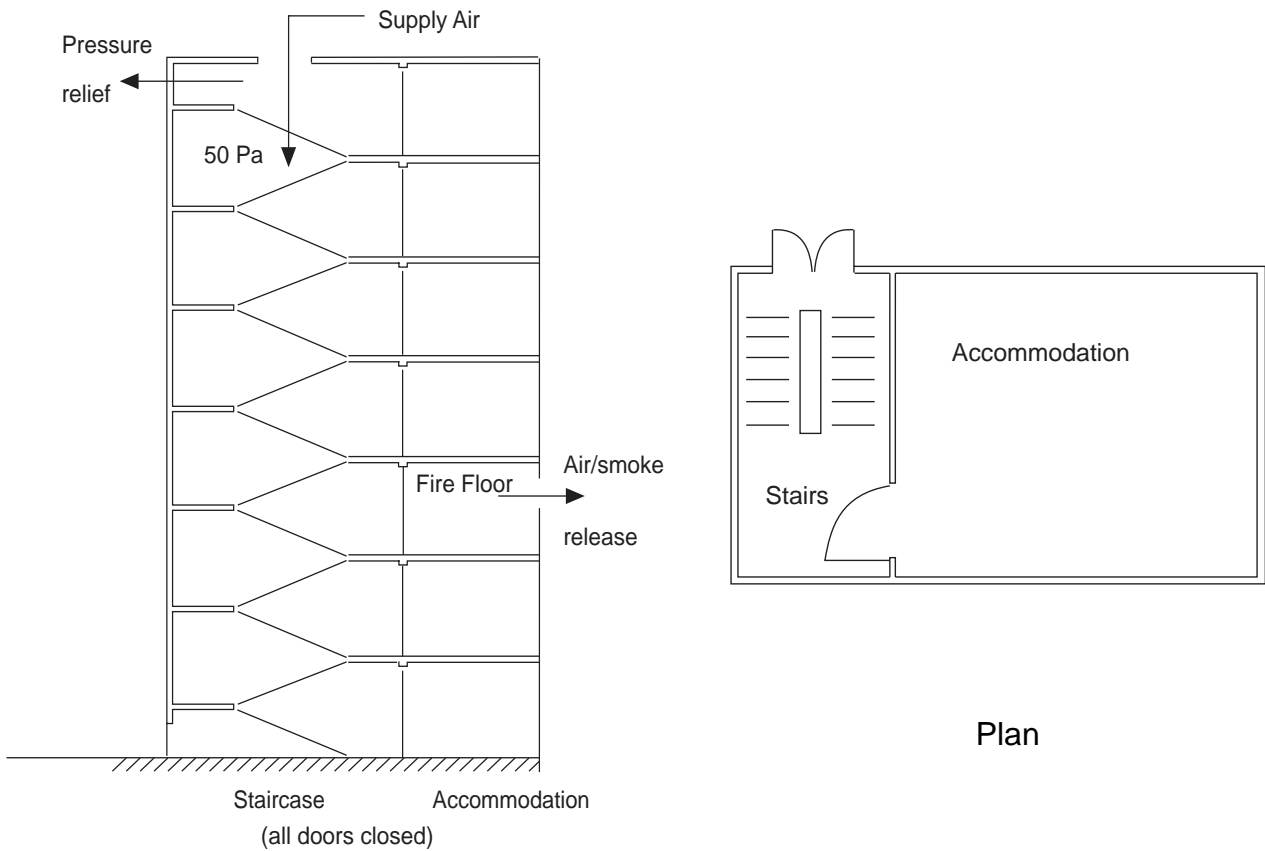

MODE 1 - PRESSURE CRITERION

REFERENCE

Leakage Area - 7 Single Doors opening in at 0.01m ²	=	0.07m ²	
1 Double Door at exit	=	0.03m ²	
A_E	=	<u>0.10m²</u>	- TABLE 2

Airflow required	=	$Q = 0.83 A_E p^{0.5}$	
	=	$0.83 \times 0.1 \times 50^{0.5}$	= 0.586m ³ /s - EQUATION 4
	+ 50%		= <u>0.880m³/s</u> - EQUATION 5

3.2 CLASS A SYSTEM - STAIRCASE ONLY PRESSURISED

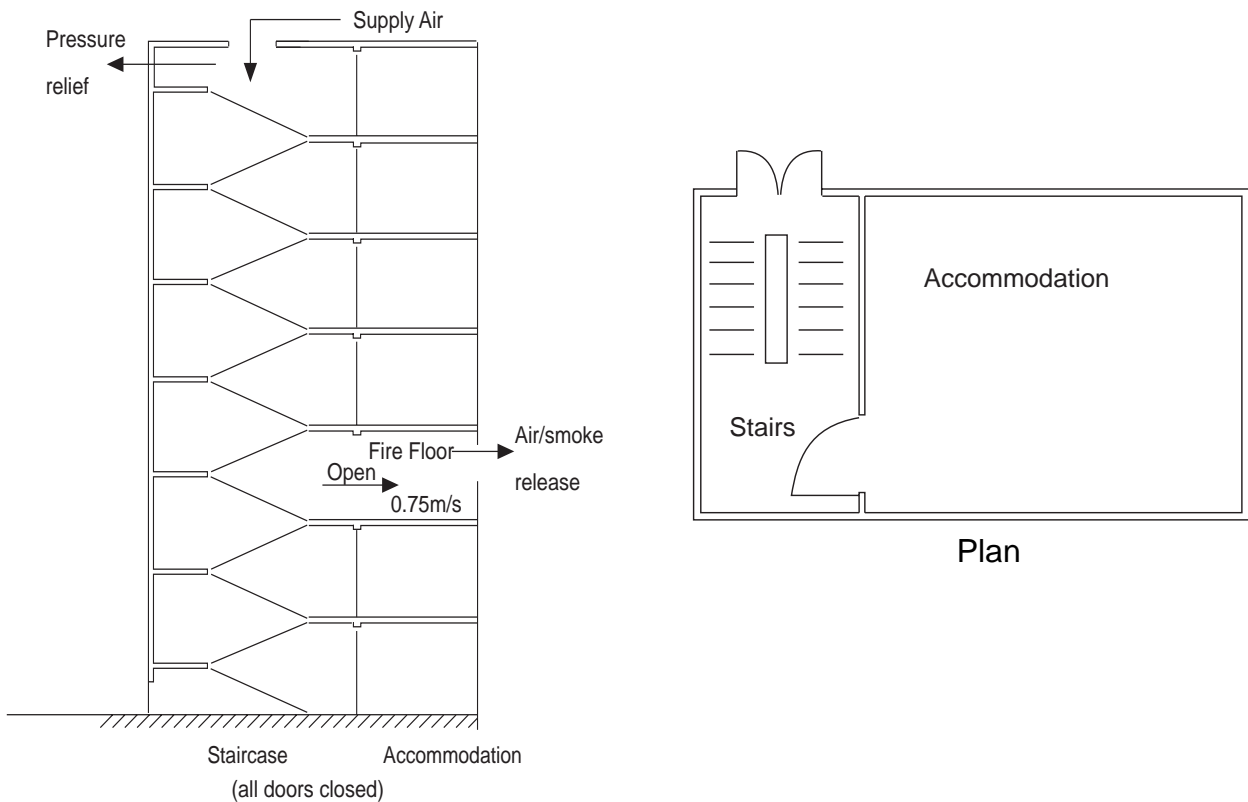

MODE 2 - VELOCITY CRITERION

REFERENCE

Airflow required through open door = $Q = A \times V$
 $= 1.6 \times 0.75 = 1.20\text{m}^3/\text{s}$ - EQUATION 1
 Plus all other leaks - Add Mode 1 $= 0.88\text{m}^3/\text{s}$
 $\underline{2.08\text{m}^3/\text{s}}$

CALCULATE AREA OF PRESSURE RELIEF

Area = $\frac{Q}{0.83 \times p^{0.5}}$ $= \frac{(2.08 - 0.88)}{0.83 \times 50^{0.5}}$ $= \underline{0.204\text{m}^2}$ - EQUATION 9

CALCULATE AREA OF AIR/SMOKE RELEASE VENTS

Airflow onto Fire Floor $= \underline{1.20\text{m}^3/\text{s}}$ - EQUATION 1 above

Area of Air/Smoke Release Vent $= \frac{Q}{2.5} = \frac{1.2}{2.5}$
 $= \underline{0.48\text{m}^2}$ - EQUATION 2

SUMMARY

Supply Fan Duty $= \underline{2.08\text{m}^3/\text{s} \text{ at } 50\text{Pa} + \text{System Resistance}}$
 Area of Pressure Relief $= \underline{0.204\text{m}^2}$
 Area of Air/Smoke Release $= \underline{0.48\text{m}^2}$

3.3 CLASS A SYSTEM - STAIRCASE & LOBBY PRESSURISED

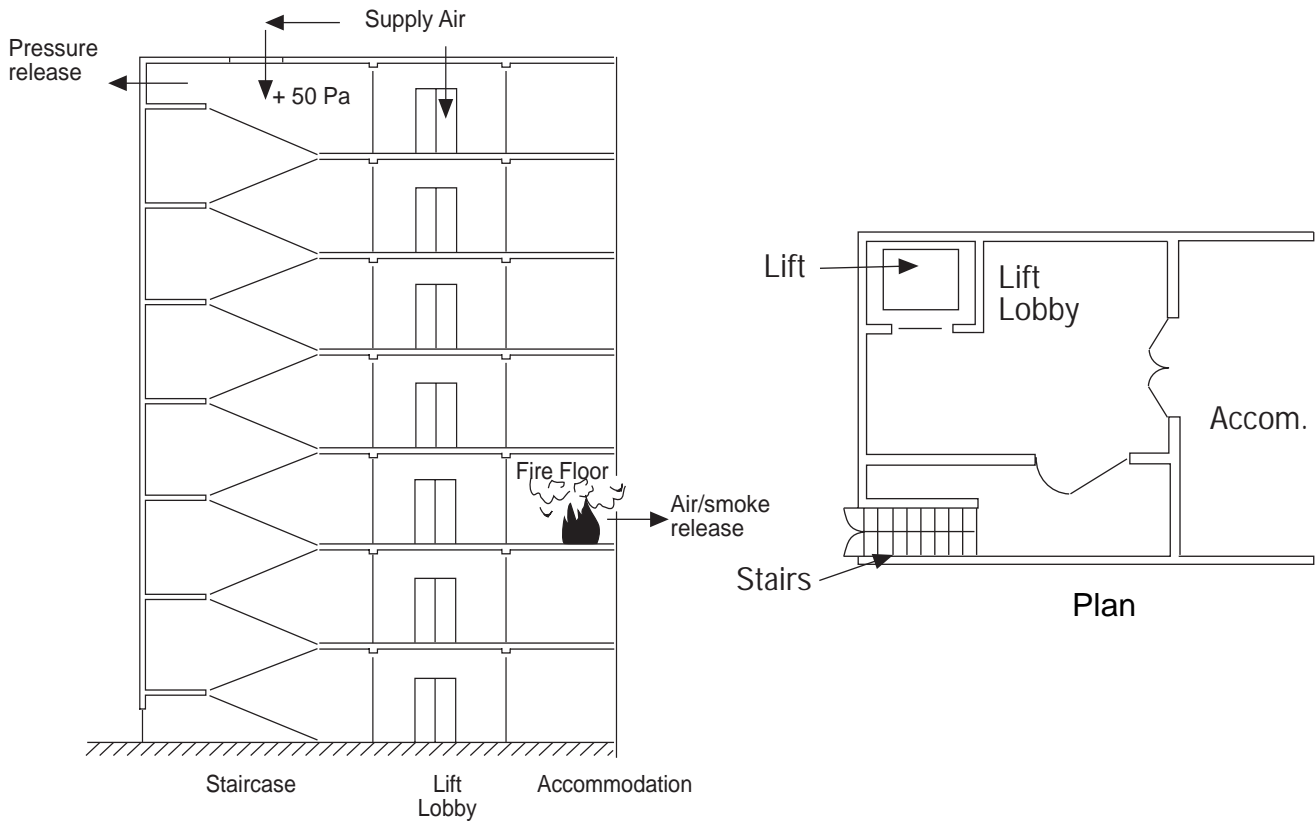

MODE 1 - PRESSURE CRITERION

REFERENCE

Stairs (Stairwell and lift lobbies pressurised - No airflow across stairwell/lobby door)

Leakage Area = 1 double door at exit = $A_E = \underline{0.03m^2}$ - TABLE 2

Airflow required = $Q = 0.83 A_E p^{0.5}$
 = $0.83 \times 0.03 \times 50^{0.5}$ = $0.176m^3/s$ - EQUATION 4
 + 50% = $\underline{0.264m^3/s}$ - EQUATION 5

Lobbies

Leakage Area = 7 double doors to accommodation at 0.03 = $0.21m^2$ - TABLE 2
 Lift top vent = $0.10m^2$
 $A_E = \underline{0.31m^2}$

Airflow required = $Q = 0.83 A_E P^{0.5}$
 = $0.83 \times 0.31 \times 50^{0.5}$ = $1.82 m^3/s$ - EQUATION 4
 + 50% = $\underline{2.73m^3/s}$ - EQUATION 5

MODE 1 Total airflow required -
 (0.264 + 2.73) = $\underline{2.994m^3/s}$
 (Say $3.0m^3/s$)

NOTE : 50% rule used for lift shaft leakage

3.4 CLASS A SYSTEM - STAIRCASE & LOBBY PRESSURISED

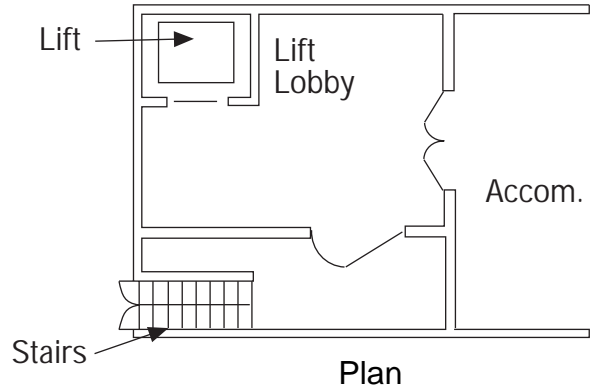
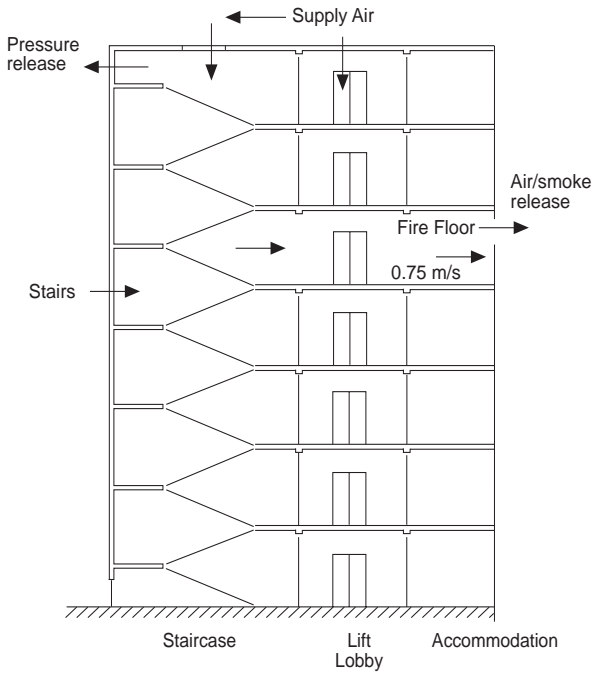

MODE 2 - VELOCITY CRITERION

REFERENCE

Airflow required through open fire floor door

$$Q = A \times V = 1.6 \times 0.75 = 1.20 \text{m}^3/\text{s} \quad \text{- EQUATION 1}$$

$$\text{Plus all other leaks} = \text{Add Mode 1} = \frac{3.00 \text{m}^3/\text{s}}{4.20 \text{m}^3/\text{s}}$$

CALCULATE AREA OF PRESSURE RELIEF

$$\text{Area} = \frac{Q}{0.83 \times p^{0.5}} = \frac{(4.20 - 3.00)}{0.83 \times 50^{0.5}} = 0.204 \text{m}^2 \quad \text{- EQUATION 9}$$

CALCULATE AREA OF AIR/SMOKE RELEASE VENT

$$\text{Airflow to Fire Floor} = 1.20 \text{m}^3/\text{s} \quad \text{- EQUATION 1}$$

$$\text{Area of Air/Smoke Release Vent} = \frac{Q}{2.5} = \frac{1.2}{2.5} = 0.48 \text{m}^2 \quad \text{- EQUATION 2}$$

SUMMARY

Supply Fan Duty	=	<u>4.20m³/s at 50Pa + System Resistance</u>
Area of Pressure Relief	=	<u>0.204m²</u>
Area of Air/Smoke Release Vent	=	<u>0.48m²</u>

3.5 CLASS B SYSTEM - FIRE FIGHTING STAIR ONLY

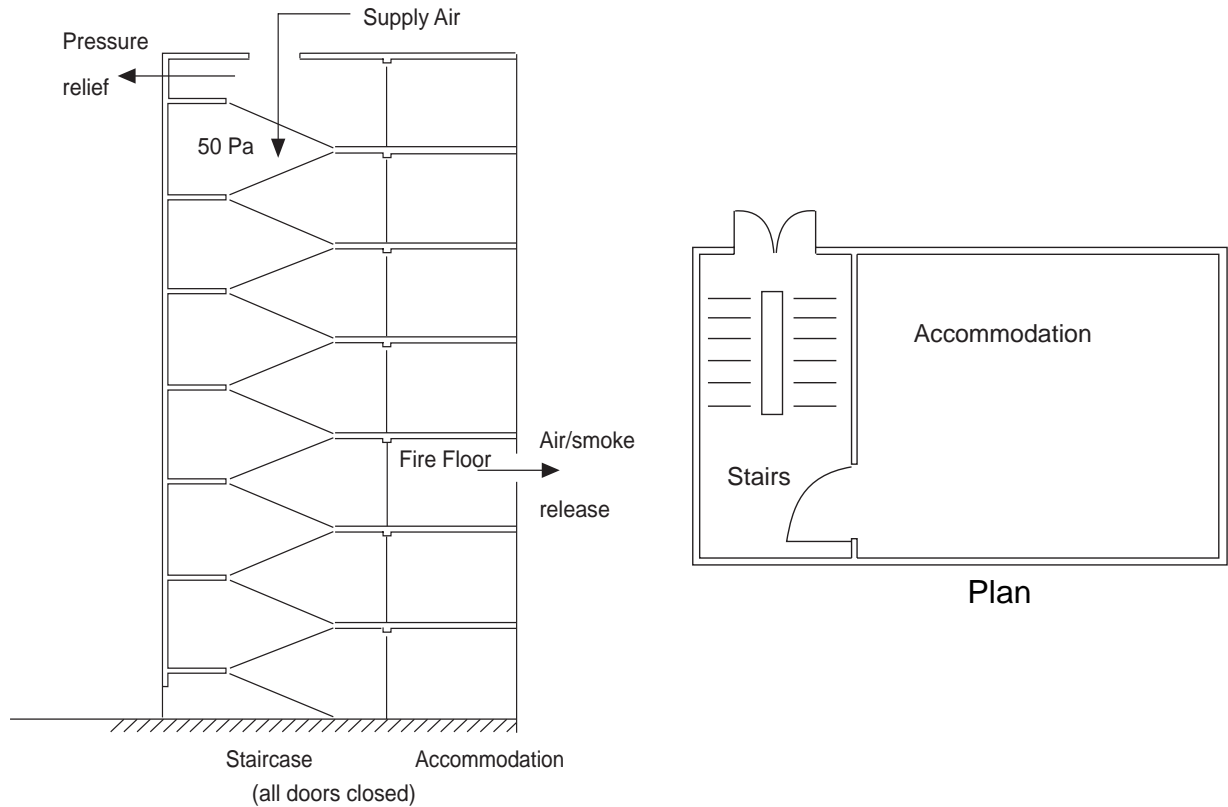

MODE 1 - PRESSURE CRITERION

REFERENCE

Leakage Area - 7 Single Doors opening in at $0.01\text{m}^2 = 0.07\text{m}^2$
 1 Double Door at exit $= 0.03\text{m}^2$
 $A_E = 0.10\text{m}^2$

- TABLE 2

Airflow required = $Q = 0.83 A_E p^{0.5}$
 $= 0.83 \times 0.1 \times 50^{0.5} = 0.586\text{m}^3/\text{s}$ - EQUATION 4
 $+ 50\% = 0.880\text{m}^3/\text{s}$ - EQUATION 5

3.6 CLASS B SYSTEM - FIRE FIGHTING STAIR ONLY

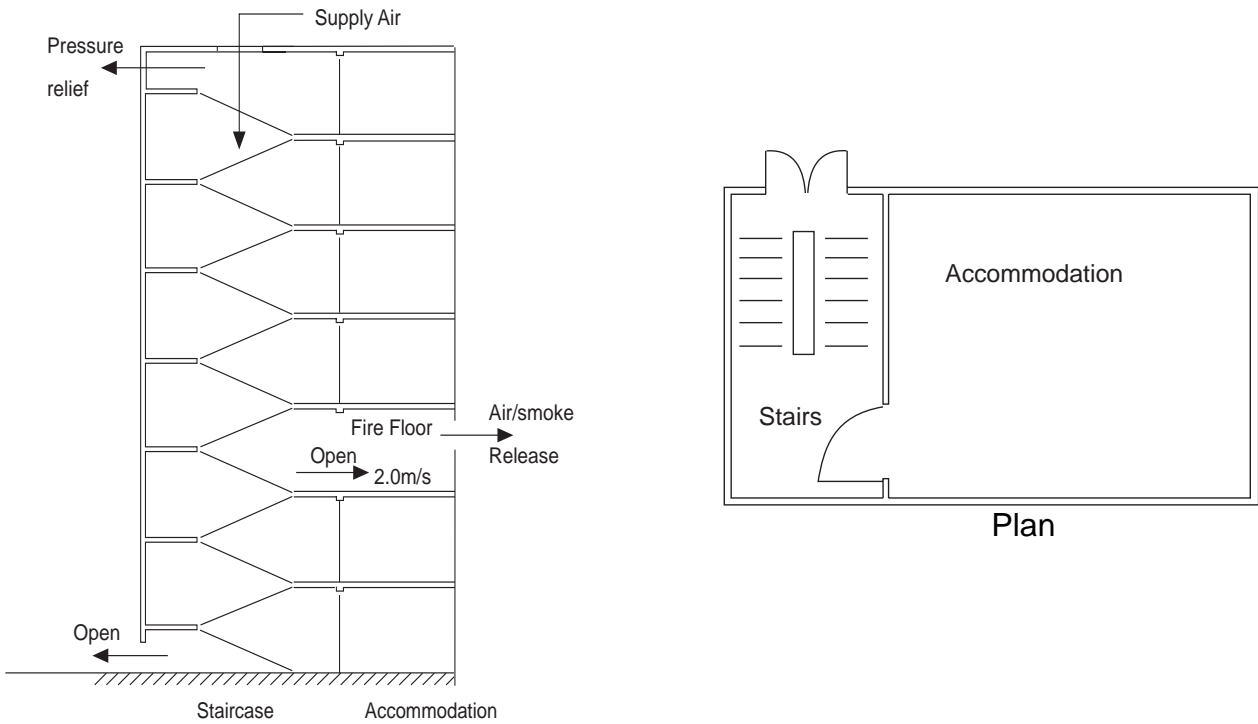

MODE 3 - FIRE FIGHTING - VELOCITY CRITERION

REFERENCE

Airflow through open Fire Floor Door = $1.6 \times 2.0 = 3.20\text{m}^3/\text{s}$
 Airflow through open exit door = $5.10\text{m}^3/\text{s}$

- EQUATION 1
 - TABLE 3
 (1 DOOR & VENT)

Add Mode I = $\frac{0.88\text{m}^3/\text{s}}{9.18\text{m}^3/\text{s}}$

CALCULATE AREA OF PRESSURE RELIEF

$$\text{Area} = \frac{Q}{0.83 \times 50^{0.5}} = \frac{(9.18 - 0.88)}{0.83 \times 50^{0.5}} = \underline{1.41\text{m}^2}$$

- EQUATION 9

CALCULATE AREA OF AIR/SMOKE RELEASE VENT

Airflow onto Fire Floor = $3.20\text{m}^3/\text{s}$ - EQUATION 1

Area of Air/Smoke = $\frac{Q}{2.5} = \frac{3.2}{2.5} = \underline{1.28\text{m}^2}$ - EQUATION 2

Fan Duty Required = $\underline{9.18\text{m}^3/\text{s} @ 50\text{Pa} + \text{System}}$
 Pressure Relief = $\underline{1.41\text{m}^2}$
 Area of Air/Smoke Release Vent = $\underline{1.28\text{m}^2}$

3.7 CLASS B SYSTEM - FIRE FIGHTING STAIRS & LIFT

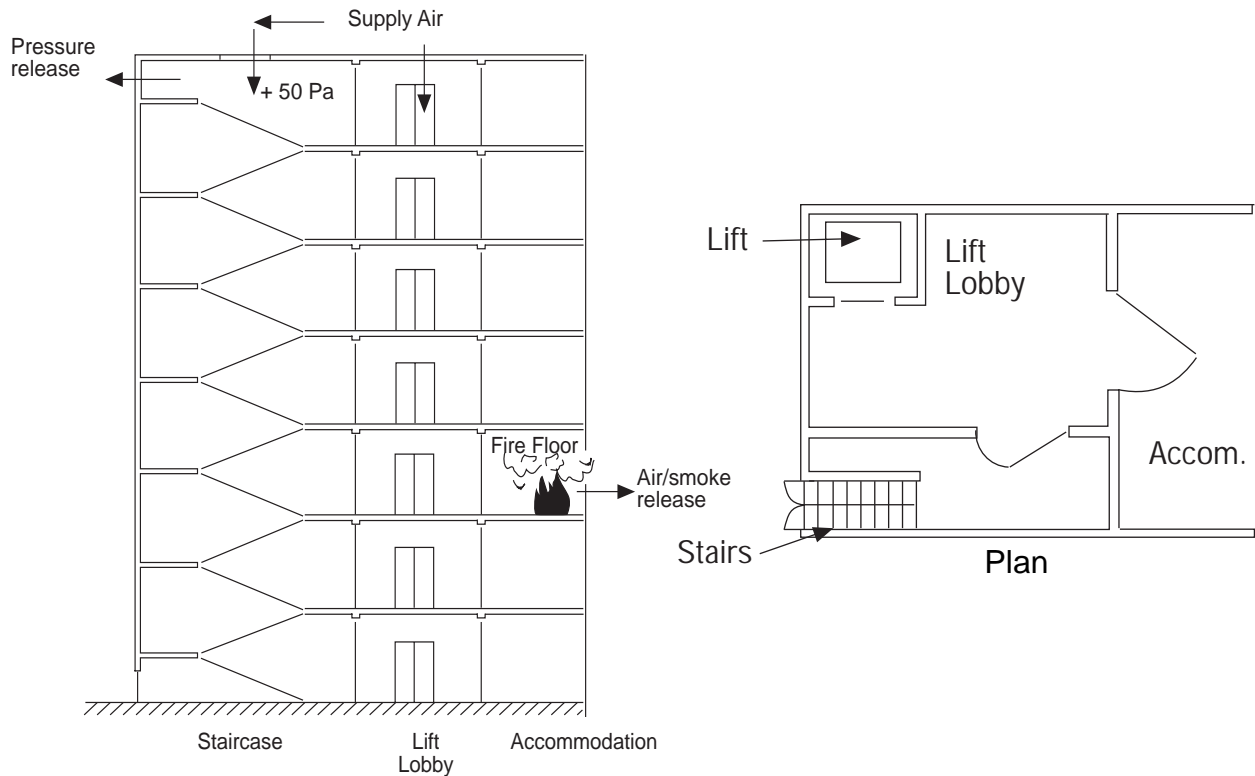

MODE 1 - PRESSURE CRITERION ALL DOORS CLOSED (No airflow across stair/lobby doors)

REFERENCE

Stairs

Leakage area	= 1 double Door At Exit	= 0.03m ²	- TABLE 2
Airflow to stairs	= Q = 0.83 A _E 50 ^{0.5}	= 0.176m ³ /s	- EQUATION 4
	+50%	= <u>0.264m³/s</u>	- EQUATION 5

Lobbies (No airflow across lift/lobby doors)

Leakage area	= 7 single doors opening out at 0.02m ²	= <u>0.14m²</u>	- TABLE 2
Airflow to lobbies	= Q = 0.83 x 0.14 x 50 ^{0.5}	= 0.821m ³ /s	- EQUATION 4
	+ 50%	= <u>1.232m³/s</u>	- EQUATION 5

Lift Shaft

Leakage area	= 1 lift top vent	= 0.10m ²	- TABLE 2
	Walls 21m high	= <u>0.12m²</u>	- TABLE 5
		<u>0.22m²</u>	
Airflow to Lift Shaft	= Q = 0.83 x 0.22 x 50 ^{0.5}	= <u>1.29m³/s</u>	- EQUATION 4

50% allowance not required - Structure leaks allowed for direct

Total Airflow Mode 1 = 1.29 + 1.23 + 0.264 = 2.78m³/s

3.8 CLASS B SYSTEM - FIRE FIGHTING STAIRS & LIFT

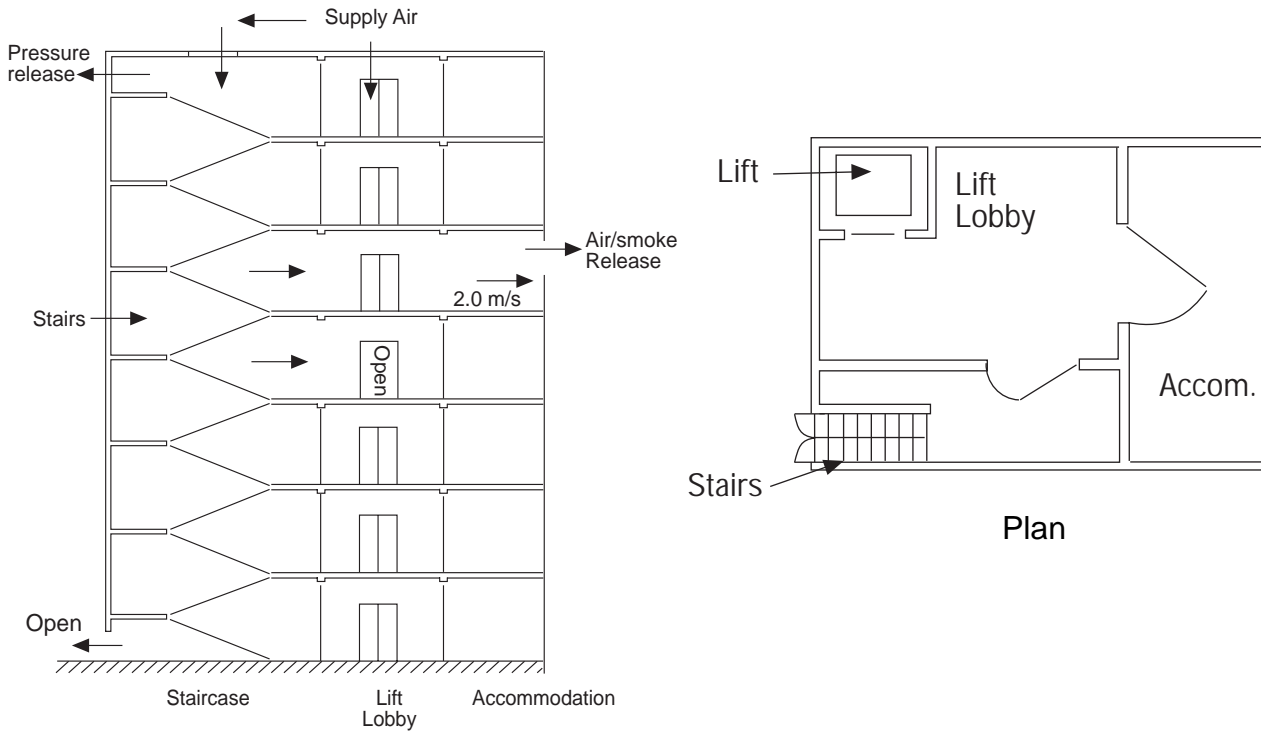

MODE 3 - FIRE FIGHTING - VELOCITY CRITERION

REFERENCE

LIFT SHAFT - (Lift door open on one floor)

Leakage Area - A_E - 1 - Open Lift Door (2m high x 1m wide) = 0.15m² - TABLE 2
 1 - Lift Top Vents = 0.10m² - TABLE 2
 Lift Shaft Walls - 21m high = 0.12m² - TABLE 5

Airflows - $Q = 0.83 A_E 50^{0.5}$ EQUATION 4
 - Open Lift Door = 0.88m³/s
 Lift top vents = 0.58m³/s
 Lift shaft walls = 0.71 m³/s
 Total Airflow to lift shaft = 2.17m³/s

Note - of which 0.88m³/s will leak into the lobby and contribute to the total airflow.

CALCULATED TOTAL AIRFLOW REQUIRED - MODE 3

Airflow to fire floor = (1.6 m² x 2.0m/s) = 3.2m³/s - EQUATION 1
 Airflow through open exit door = 5.93m³/s - TABLE 3 (2 Doors & Vent)
 Airflow to lift shaft = 2.17m³/s
 Airflow through all other leaks (add Mode 1 minus lift shaft) - 2.78 - (0.58 + 0.71) = 1.49m³/s
 12.79m³/s
 minus airflow through lift door - (from above) = 0.88m³/s
 = 11.91m³/s

CALCULATE AREA OF PRESSURE RELIEF

Area of Pressure Relief = $\frac{Q}{0.83 \times p^{0.5}} = \frac{(11.91 - 2.78)}{0.83 \times 50^{0.5}} = 1.56m^2$ - EQUATION 9

CALCULATE AREA OF AIR/SMOKE RELEASE VENT

Airflow to Fire Floor = 3.2m³/s - EQUATION 1
 Area of Air/smoke Release Vent = $\frac{3.2}{2.5} = 1.28m^2$ - EQUATION 2
 Fan Duty Required = 11.91m³/s @ 50Pa + System Resistance
 Pressure Relief = 1.56m²
 Area of Air/Smoke Release Vent = 1.28m²

3.9 CLASS C SYSTEM - STAIRCASE ONLY PRESSURISED

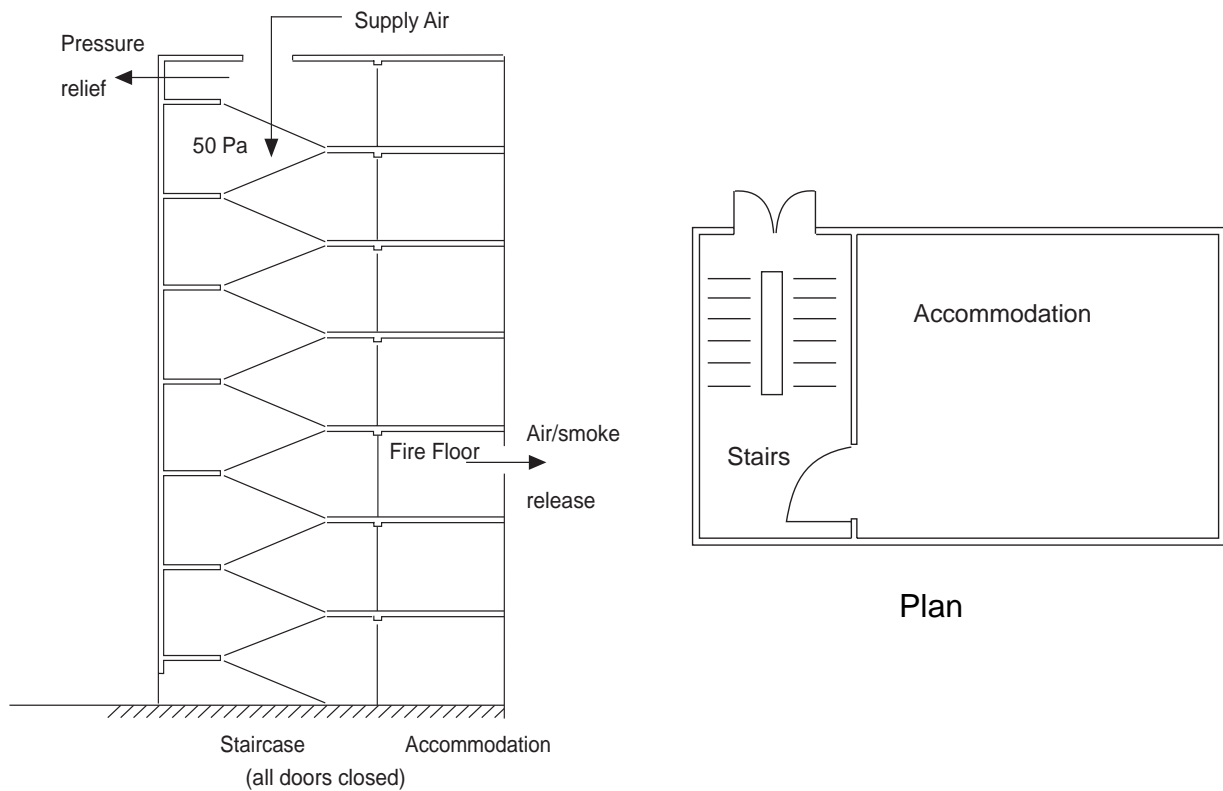

MODE 1 - PRESSURISATION CRITERION

REFERENCE

Leakage Area	- 7 single doors opening in at 0.01m ²	= 0.07	
	1 Double Door at exit	= 0.03	
	A_E	= <u>0.10m²</u>	- TABLE 2
Airflow required to Stairs	= $Q = 0.83 A_E 50^{0.5}$		
	= $0.83 \times 0.1 \times 50^{0.5}$	= 0.586m ³ /s	- EQUATION 4
	+ 50%	= <u>0.88m³/s</u>	- EQUATION 5

3.10 CLASS C SYSTEM - STAIRCASE ONLY PRESSURISED

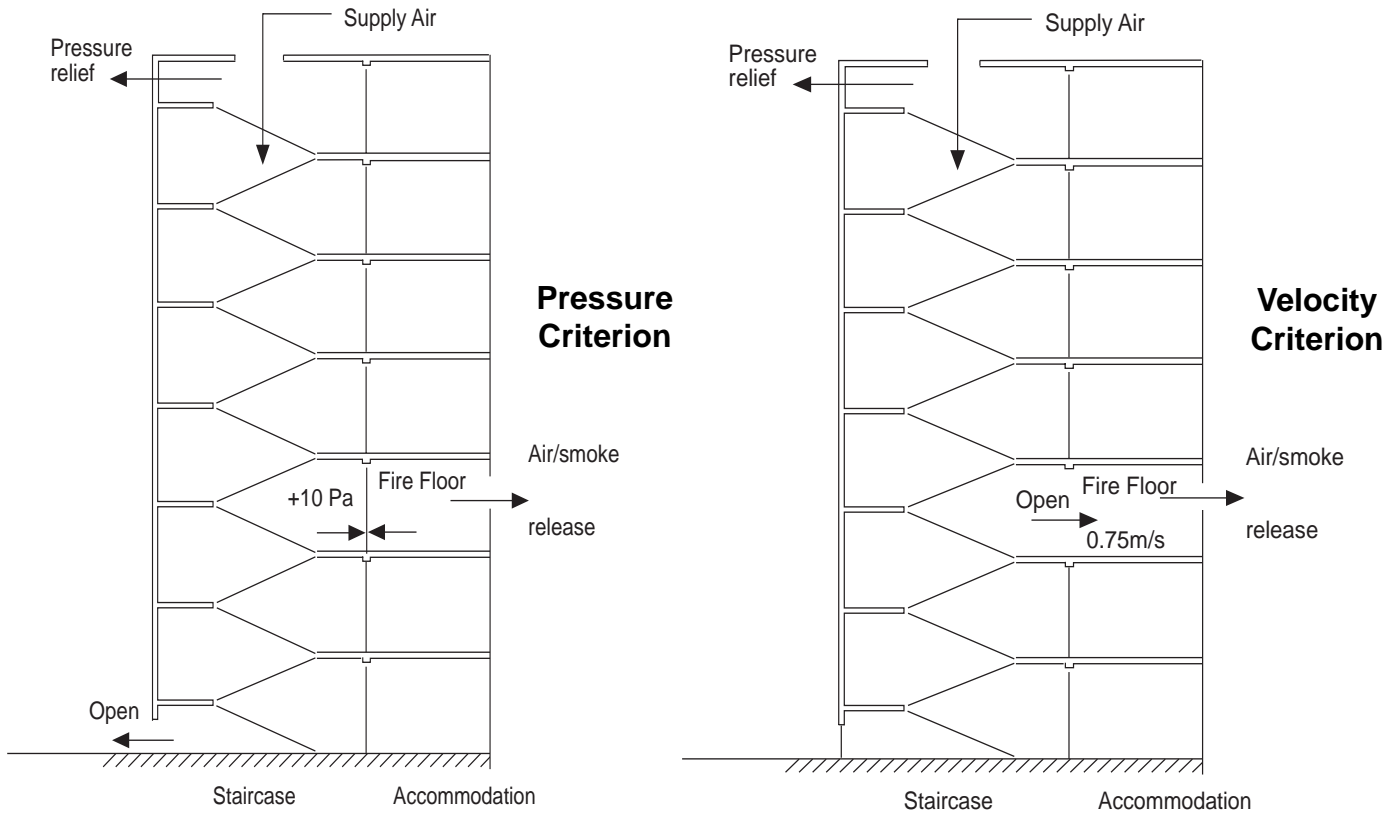

MODE 2 - PRESSURE CRITERION

Airflow through open exit door (1.6m²)
Add Mode 1

$$= 4.19\text{m}^3/\text{s}$$

$$= 0.88\text{ m}^3/\text{s}$$

$$\underline{5.07\text{m}^3/\text{s}}$$

REFERENCE

- TABLE 3
(1 door & Vent)

MODE 2 - VELOCITY CRITERION

Airflow through open fire door = (1.6x 0.75)
Add Mode 1

$$= 1.20\text{m}^3/\text{s}$$

$$= 0.88\text{m}^3/\text{s}$$

$$\underline{2.08\text{m}^3/\text{s}}$$

- EQUATION 1

Note: **Mode 2 - Pressure Criterion Determines Fan Duty**

CALCULATE AREA OF PRESSURE RELIEF

$$\text{Area of Pressure Relief} = \frac{Q}{0.83 \times P^{0.5}} = \frac{(5.07 - 0.88)}{0.83 \times 50^{0.5}} = \underline{0.71\text{m}^2} \quad \text{- EQUATION 9}$$

CALCULATE AREA OF AIR/SMOKE RELEASE VENT

$$\begin{aligned} \text{Airflow to fire floor} &= 1.20\text{m}^3/\text{s} && \text{- EQUATION 1} \\ \text{Area of Air/Smoke Release Vent} &= \frac{Q}{2.5} = \frac{1.2}{2.5} \\ &= \underline{0.48\text{m}^2} && \text{- EQUATION 2} \end{aligned}$$

$$\begin{aligned} \text{Fan Duty required} &= \underline{5.07\text{m}^3/\text{s} \text{ at } 50\text{Pa} + \text{System Resistance}} \\ \text{Area of Pressure Relief} &= \underline{0.71\text{m}^2} \\ \text{Area of Air/Smoke Release vent} &= \underline{0.48\text{m}^2} \end{aligned}$$

CLASS D SYSTEMS - STAIRCASE ONLY PRESSURISED

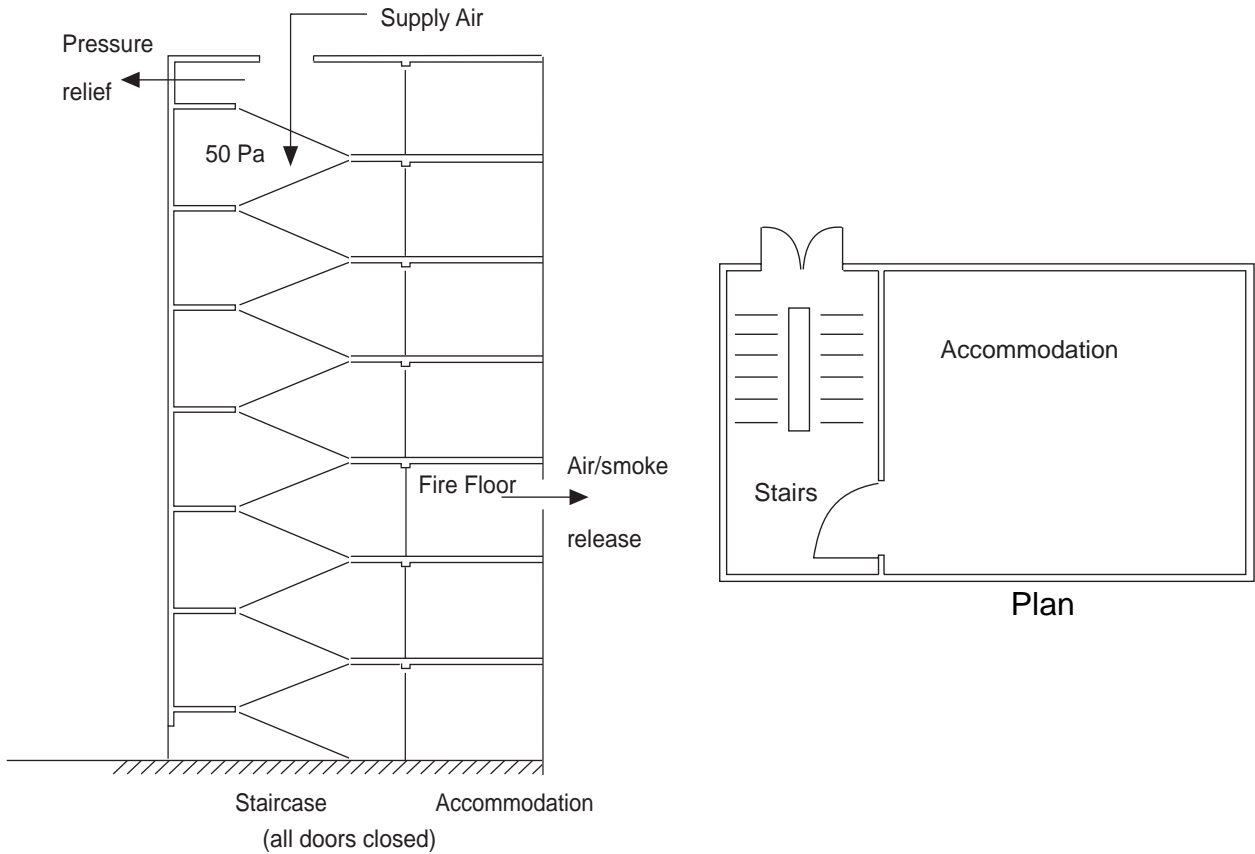

MODE 1 - ALL DOORS CLOSED

REFERENCE

Leakage Area = 7 single doors to accommodation at 0.01m ²	= 0.07m ²	
1 Double Door at Exit	= <u>0.03m²</u>	
A_E	= <u>0.10m²</u>	- TABLE 2
Airflow required to stairs = $Q = 0.83 A_E 50^{0.5}$		
= $0.83 \times 0.1 \times 50^{0.5}$	= 0.586m ³ /s	- EQUATION 4
+ 50%	= <u>0.880m³/s</u>	- EQUATION 5

3.11 CLASS D SYSTEMS - STAIRCASE ONLY PRESSURISED

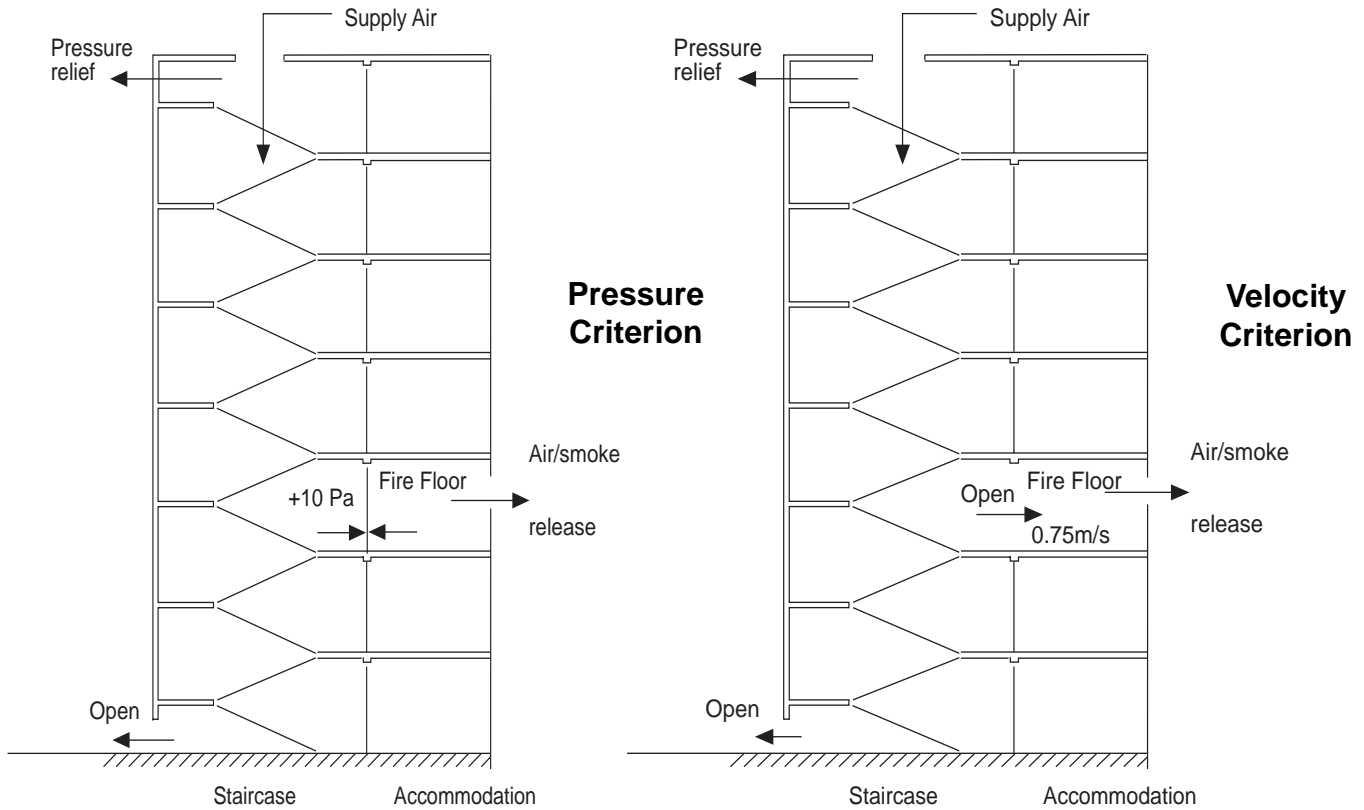

MODE 2 - PRESSURE CRITERION

Airflow through open exit door (1.6m²)
Add Mode 1

$$= 4.19\text{m}^3/\text{s}$$

$$\underline{\underline{\frac{0.88\text{m}^3/\text{s}}{5.07\text{m}^3/\text{s}}}}$$

REFERENCE

- TABLE 3
(1 Door & Vent)

MODE 2 - VELOCITY CRITERION

Airflow through open fire floor door = (1.6 x 0.75)
Airflow through open exit door =
Add Mode 1

$$= 1.20\text{m}^3/\text{s}$$

$$= 4.19\text{m}^3/\text{s}$$

$$\underline{\underline{\frac{0.88\text{m}^3/\text{s}}{6.27\text{m}^3/\text{s}}}}$$

- EQUATION 1
- TABLE 3
(1 door & Vent)

Note: **Mode 2 - Velocity Criterion Determines Fan Duty**

CALCULATE AREA OF PRESSURE RELIEF

$$\text{Area of Pressure Relief} = \frac{Q}{0.83 \times p^{0.5}} = \frac{(6.25 - 0.88)}{0.83 \times 50^{0.5}} = \underline{\underline{0.915\text{m}^2}} \quad \text{- EQUATION 9}$$

CALCULATE AREA OF AIR/SMOKE RELEASE VENT

$$\begin{aligned} \text{Airflow to Fire floor} &= 1.20\text{m}^3/\text{s} && \text{- EQUATION 1} \\ \text{Area of Air/Smoke Release Vent} &= \frac{Q}{2.50} = \frac{1.20}{2.50} \\ &= \underline{\underline{0.48\text{m}^2}} && \text{- EQUATION 2} \end{aligned}$$

$$\begin{aligned} \text{Fan Duty Required} &= \underline{\underline{6.25\text{m}^3/\text{s} @ 50\text{Pa} + \text{System}}} \\ \text{Area of Pressure Relief} &= \underline{\underline{0.915\text{m}^2}} \\ \text{Area of Air/Smoke Release Vent} &= \underline{\underline{0.48\text{m}^2}} \end{aligned}$$

3.12 CLASS E SYSTEMS - STAIRCASE ONLY PRESSURISED

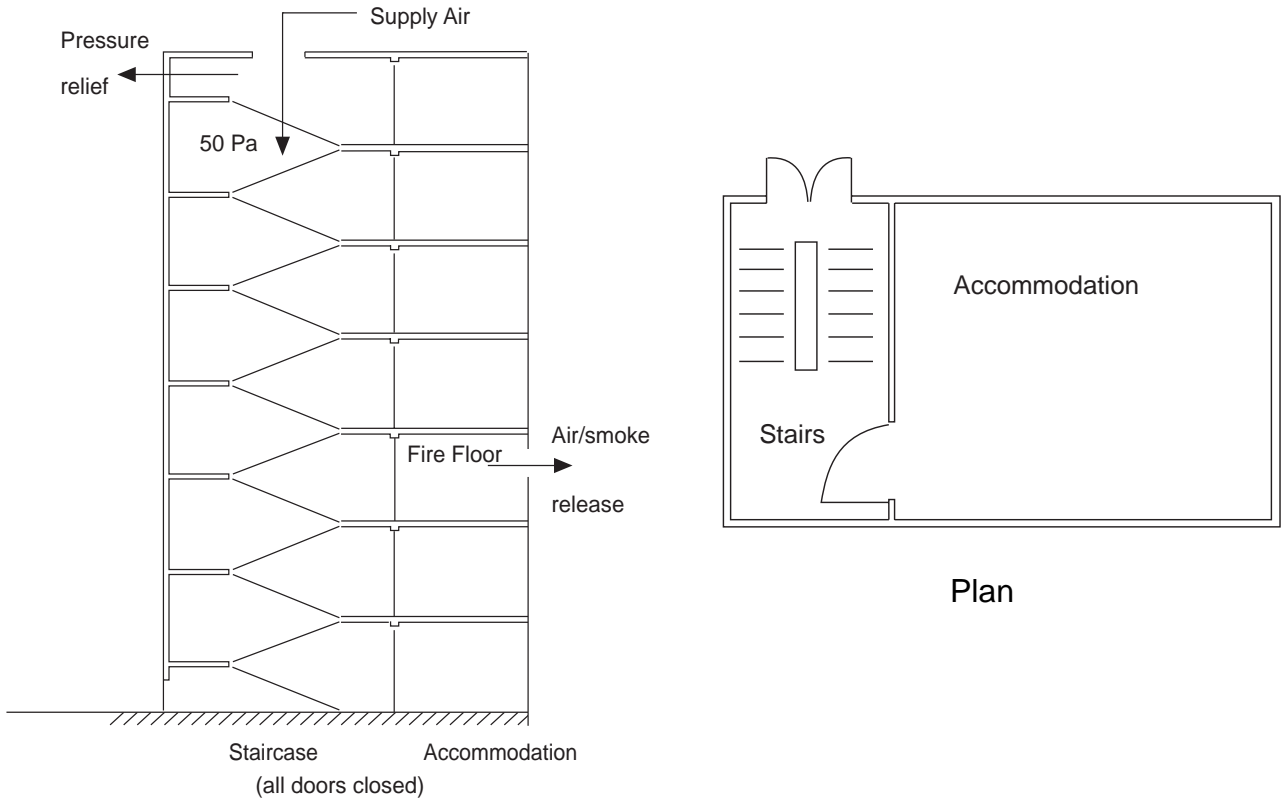

MODE 1 - ALL DOORS CLOSED

REFERENCE

Leakage Area =	7 single doors to accommodation at 0.01m ²	= 0.07m ²	
	1 double door at exit	= 0.03m ²	
	A_E	= 0.10m²	- TABLE 2
Airflow required to stairs =	$Q = 0.83 A_E 50^{0.5}$		
	$0.83 \times 0.1 \times 50^{0.5}$	= 0.586m ³ /s	- EQUATION 4
		= 0.880m³/s	- EQUATION 5

3.13 CLASS E SYSTEMS - STAIRCASE ONLY PRESSURISED

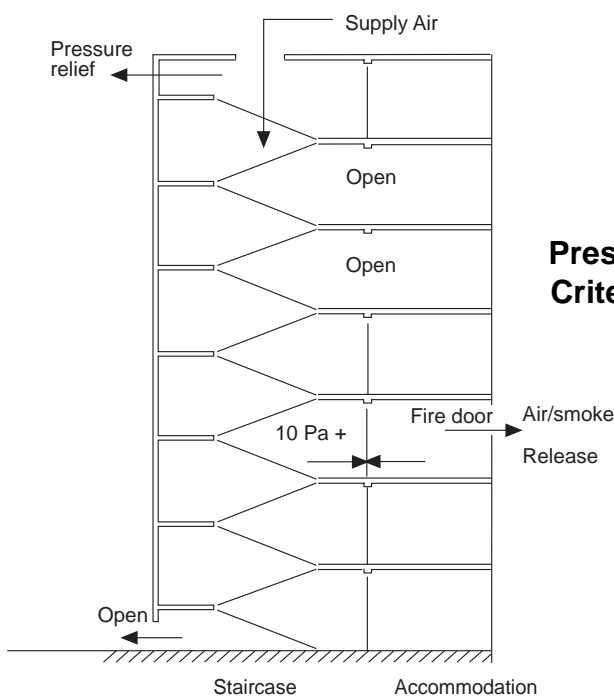

**Pressure
Criterion**

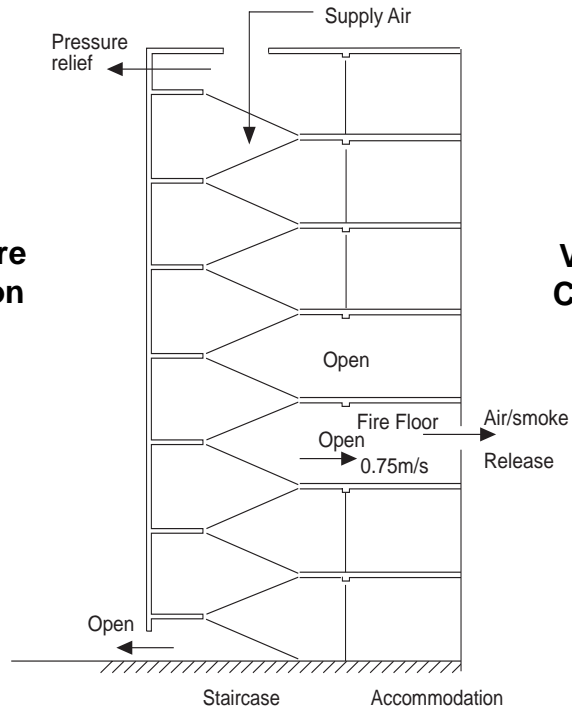

**Velocity
Criterion**

MODE 2 - PRESSURE CRITERION

Airflow through open exit door (1.6m²)

$$= 4.19\text{m}^3/\text{s}$$

REFERENCE

- TABLE 3
(1 door & Vent)

Airflow through two open accommodation doors
assuming open accommodation area at 900m²

$$= 0.574\text{m}^3/\text{s}$$

- TABLE 4

$$0.574\text{m}^3/\text{s}$$

- TABLE 4

Add Mode 1

$$\underline{0.88\text{m}^3/\text{s}}$$

$$\underline{6.218\text{m}^3/\text{s}}$$

MODE 2 - VELOCITY CRITERION

Airflow through open fire floor door = 1.6 x 0.75 = 1.20m³/s

- EQUATION 1

Airflow through open exit door 1.6m²

$$= 4.19\text{m}^3/\text{s}$$

- TABLE 3

(1 door & Vent)

Airflow through open accommodation door 900m²

$$0.574\text{m}^3/\text{s}$$

- TABLE 4

Add Mode 1

$$\underline{0.88\text{m}^3/\text{s}}$$

$$\underline{6.824\text{m}^3/\text{s}}$$

Note: Mode 2 = Velocity Criterion Determines Fan Duty

CALCULATE AREA OF PRESSURE RELIEF

$$\text{Area of Pressure Relief} = \frac{Q}{0.83 \times p^{0.5}} = \frac{(6.82 - 0.88)}{0.83 \times 50^{0.5}} = \underline{1.01\text{m}^2}$$

CALCULATE AREA OF AIR/SMOKE RELIEF VENT

Airflow to Fire Floor = 1.20m³/s - EQUATION 1

$$\text{Area of Air/Smoke Relief Vent} = \frac{Q}{2.50} = \frac{1.20}{2.50}$$

$$= \underline{0.48\text{m}^2} \quad \text{- EQUATION 2}$$

Fan Duty Required = 6.824m³/s @ 50Pa + System

Area of Pressure Relief = 1.01m²

Area of Relief Vent = 0.48m²

3.14 CLASS E SYSTEM - STAIRCASE & LOBBY PRESSURISED

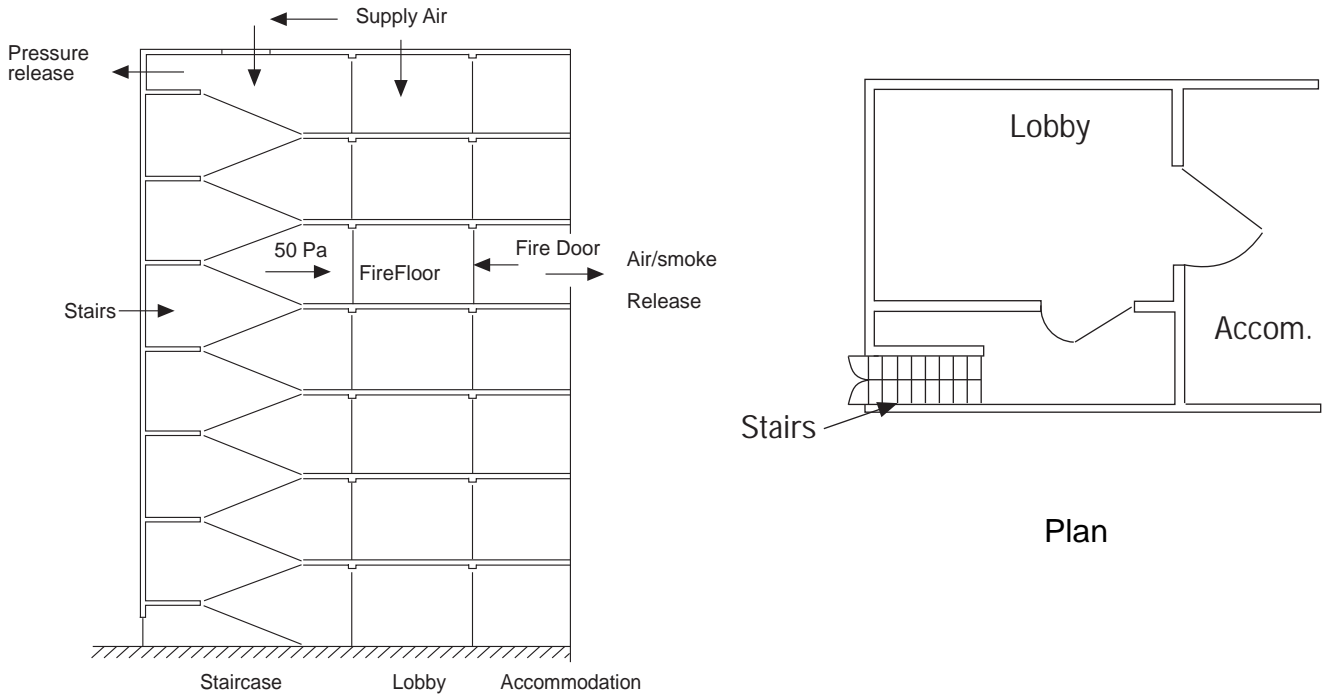

MODE 1 - ALL DOORS CLOSED

REFERENCE

Stairs

There will be no flow through Stairs/Lobby Doors

Leakage Area	= 1 x Double Door at exit $A_E = 0.03\text{m}^2$	- TABLE 2
Airflow required to (Stairs)	$= Q = 0.83 A_E^{0.5}$	
	$= 0.83 (0.03) \times 50^{0.5} = \underline{0.176\text{m}^3/\text{s}}$	- EQUATION 4
	+ 50%	$\underline{0.264\text{m}^3/\text{s}}$ - EQUATION 5

Lobbies

Leakage Area	= 7 x Single doors opening out at 0.02	= 0.14m^2	- TABLE 2
Airflow required to (Lobbies)	$= Q = 0.83 A_E^{0.5}$		
	$= 0.83 (0.03) \times 50^{0.5} = \underline{0.82\text{m}^3/\text{s}}$		- EQUATION 4
	+ 50%	$= \underline{1.23\text{m}^3/\text{s}}$	- EQUATION 5

Total Airflow Required Mode 1 = 1.23 + 0.264 = 1.494m³/s

3.15 CLASS E SYSTEM - STAIRCASE & LOBBY PRESSURISED

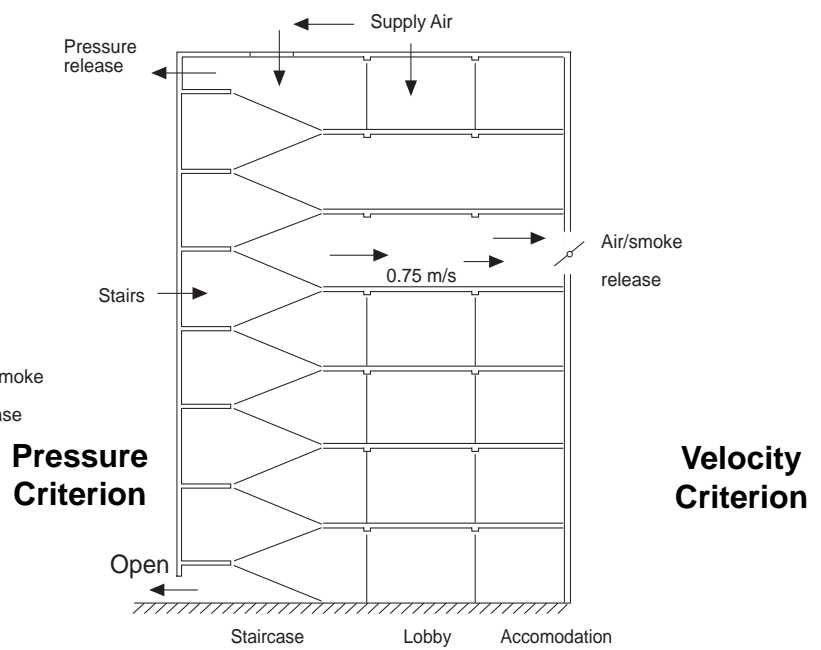
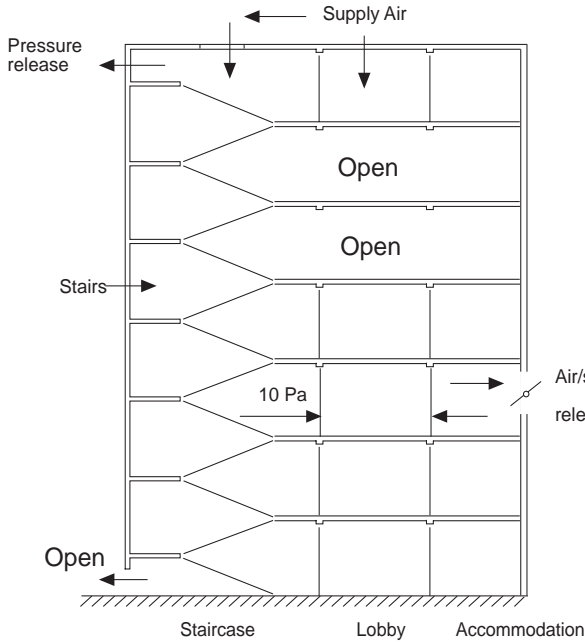

MODE 2 - PRESSURE CRITERION

Airflow through open exit door 1.6m ²		= 4.36m ³ /s	
Airflow through two open accommodation doors 900m ²	= (2 x 0.574)	= 1.148m ³ /s	
Add Mode 1		= 1.494m ³ /s	
Total Airflow		= 7.002m ³ /s	

REFERENCE

- TABLE 3
- (2 doors & Vent)
- TABLE 4

Airflow to Stairs	= (7.002-1230)	= 5.772m ³ /s
Airflow to Lobbies		= 1.230m ³ /s

MODE 2 - VELOCITY CRITERION

Airflow through open Fire Floor Door	= 1.6 x 0.75	= 1.20m ³ /s	- EQUATION 1
Airflow through open exit door		= 4.36m ³ /s	- TABLE 3
			(2 doors & Vent)
Airflow through open accommodation door 900m ²		= 0.574m ³ /s	- TABLE 4
Add Mode 1		= 1.494m ³ /s	
Total Airflow		7.628m ³ /s	

Airflow to Stairs	= (7.628-1.230)	= 6.398m ³ /s
Airflow to Lobbies		= 1.23m ³ /s

Note:(Mode 2 - Velocity Criterion Determines Fan Duty)

CALCULATE AREA OF PRESSURE RELIEF

$$\text{Area of Pressure Relief} = \frac{Q}{0.83 + p^{0.5}} \frac{(7.628 - 1.23)}{0.83 \times 50^{0.5}} = 1.09\text{m}^2 \quad \text{- EQUATION 9}$$

CALCULATE AREA OF AIR/SMOKE RELIEF VENT

Airflow to Fire floor	=	1.20m ³ /s	b	- EQUATION 1
Area of air/Smoke Relief Vent	=	$\frac{Q}{2.5}$	=	$\frac{1.20}{2.50}$
			=	0.48m ²
				- EQUATION 1

Fan Duty Required	=	<u>7.628m³/s @ 50 Pa + System</u>
Area of Pressure Relief	=	<u>1.09m²</u>
Area of Air/Smoke Release Vent	=	<u>0.48m²</u>

4. FAN SELECTION

The fan performance and dimensional data is included with this paper to enable designers to quickly size a suitable supply fan for a particular system.

The Performance Curves are taken from Woods JM Aerofoil Fan Data and are presented as "Block Curves" covering the performance range of a particular fan on a Total Pressure/Volume Flow Scale.

The example outlined on the curves and tables are the Class B System - Fire-fighting Stair & Lifts

Fan Duty Required	=	11.91m ³ /sec at 300Pa (Total Pressure)
Fan Selected	=	90JM/25/4/6/.....
Motor Rating	=	9.0kW @ 32° PA
Physical Size (max.)	=	1006mm dia. x 520mm long
Weight	=	183 kg

This may not be the only, or indeed, the best selection for this particular duty, but will at least allow design work to proceed whilst the selection is being refined by Woods Engineers.

In addition, all fans both supply and extract, for pressurisation system, are now required to be provided with 100% Standby. Mounting the two fans in series will create additional resistance on the running fan and the fan duty will need modifying to allow for this. Again, Wood's Engineers should be consulted.

Woods Air Movement Engineers are trained in the application of the fans for Pressurisation System and are able to provide advice and support during the design and fan selection stages.

A list of name contacts is detailed on Appendix 1.



PERFORMANCE DATA

JM Aerofoils - Supply Air Fans

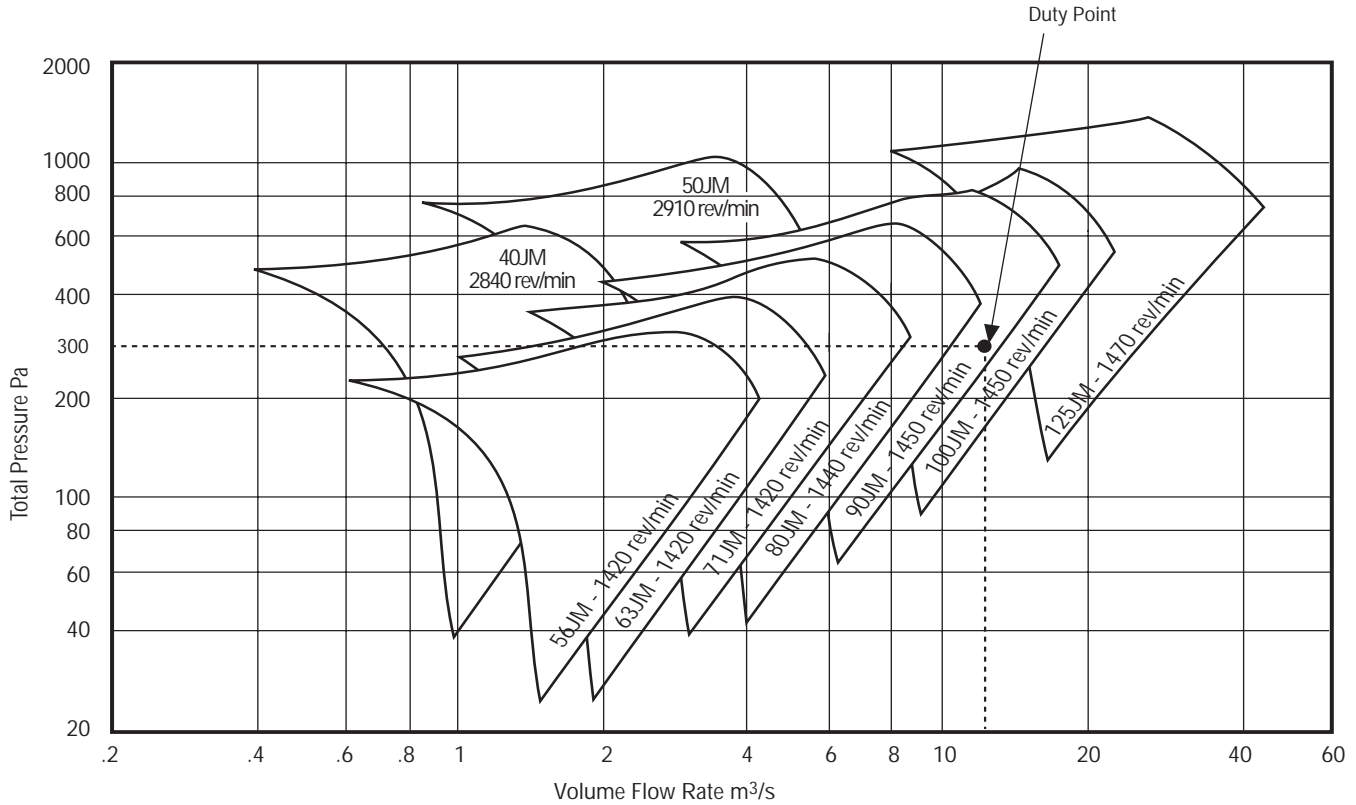

Code	Speed rev/min	dB(A) @ 3m	Pitch Angle (°) min/max	m ³ /sec @ Pa								380-420 V / 50 Hz / 3φ			
				0	50	100	200	300	400	500	Motor	Motor Rating (kW)	Full Load Current (at 400 V) (A)	Starting Current (at 400 V) (A)	
40JM/16/2/5...	2840	67	8°	1.0	0.95	0.9	0.8	0.7	0.5	-	BT9	0.58	1.4	6.0	
		67	32°	2.6	2.5	2.4	2.25	2.1	1.85	1.6	CT9	1.70	3.5	20.0	
50JM/20/2/6...	2910	77	8°	2.1	2.0	1.9	1.8	1.6	1.5	1.4	CT9	1.70	3.5	20.0	
		73	24°	4.3	4.2	4.1	4.0	3.8	3.6	3.4	F2225	3.80	7.1	44.0	
56JM/20/4/6...	1420	61	8°	1.5	1.4	1.3	0.7				BT9	0.3	0.9	4.6	
		64	38°	4.2	4.0	3.2	3.0				CT9	1.4	3.5	14.0	
63JM/20/4/6...	1420	67	8°	2.0	1.8	1.6	1.3				CT5	0.58	1.7	6.5	
		69	36°	6.0	5.6	5.3	4.6				F2225	2.7	5.8	30.0	
71JM/20/4/6...	1420	69	8°	3.1	2.8	2.6	2.2	1.6			CT9	1.4	3.5	14.0	
		69	36°	8.8	8.4	8.0	7.3	6.3			F2249	4.4	9.3	52.0	
80JM/25/4/6...	1440	72	8°	4.2	4.0	3.8	3.0	2.0			F2245	2.1	4.7	30.0	
		75	36°	11.2	10.8	10.5	9.6	8.0			D132/18	6.3	12.8	85.0	
90JM/25/4/6...	1450	75	8°	6.2	5.9	5.6	4.7	3.8	2.5		F2245	2.1	4.7	30.0	
		79	32°	15.2	14.6	14.1	13.2	12.0	10.5		D132/24	9.0	18.3	127.0	
100JM/25/4/6...	1450	78	8°	9.0	7.0	8.0	7.0	6.0	4.5	3.5	F2249	4.4	9.3	52.0	
		83	32°	22.0	21.0	20.0	18.5	17.5	15.5	13.5	D160/26	17.0	33.0	185.0	
125JM/40/4/9...	1470	90	8°	17.0	16.6	16.3	15.9	15.1	14.7	14.0	D200/57	17.0	33.0	185.0	
		91	32°	44.0	43.4	42.8	42.0	41.0	39.5	38.0	W225/MF	73.0	135.0	1010.0	

Notes

Fans detailed above are a small selection from the JM Aerofoil range, chosen to cover most Pressurisation System duties. They are not the only fans available and alternatives may better suit the requirements of a particular system, see publication JM/SS, C23a or C1a. 100 % standby can be provided by mounting JM Aerofoils in either series or parallel. Please Consult Woods technical staff for advise on fan selection.

DIMENSIONS AND WEIGHTS

Aerofoils (L Type)

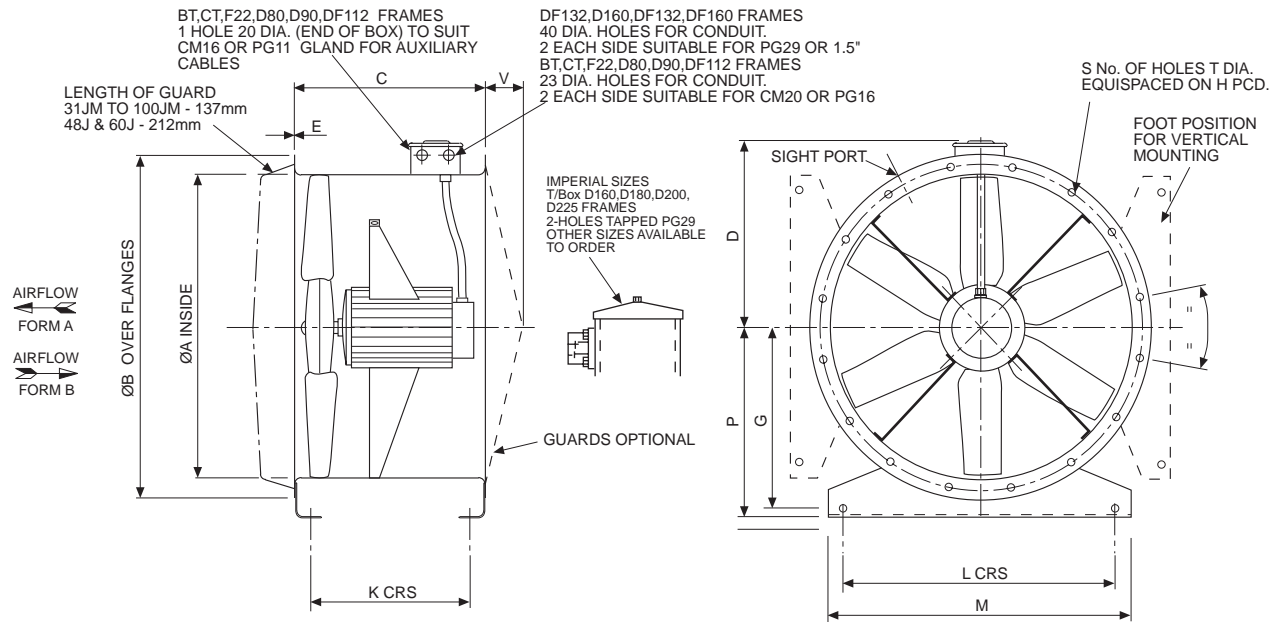

Code	Motor Frame	DIMENSION REFERENCE (mm)														Weight (kg)	
		A	B	C	D	E	G	H	K	L	M	N	P	S	T		V
31JM	CT5 D80	315	395	375	235	2.5	175	355	289	265	315	10	200	8	10	30	27
		315	395	375	235	2.5	175	355	289	265	315	10	200	8	10	30	31
40JM	BT9 CT5	400	480	375	279	2.5	225	450	289	350	400	10	250	8	12	30	26
		400	480	375	279	2.5	225	450	289	350	400	10	250	8	12	30	30
45JM	F2229 DF112	450	530	520	306	3	255	500	434	400	450	10	280	8	12	30	55
		450	530	520	306	3	255	500	434	400	450	10	280	8	12	30	72
50JM	CT9 F2225 F2229 DF112	500	594	375	338	2.5	290	560	289	450	500	10	315	12	12	30	34
		500	594	520	338	3	290	560	434	450	500	10	315	12	12	30	54
		500	594	520	338	3	290	560	434	450	500	10	315	12	12	30	65
		500	594	520	338	4	290	560	434	450	500	10	315	12	12	30	77
56JM	BT9 CT9 F2245 F2229 D90 DF112	560	654	375	368	2.5	330	620	289	510	560	10	355	12	12	50	34
		560	654	375	368	2.5	330	620	289	510	560	10	355	12	12	50	38
		560	654	520	368	3	330	620	434	510	560	10	355	12	12	50	56
		560	654	520	368	3	330	620	434	510	560	10	355	12	12	50	67
		560	654	520	368	3	330	620	434	510	560	10	355	12	12	50	58
63JM	CT5 F2225 F2249 DF112 DF160	630	724	375	403	3	375	690	289	580	630	10	400	12	12	50	52
		630	724	520	403	3	375	690	434	580	630	10	400	12	12	50	70
		630	724	520	403	3	375	690	434	580	630	10	400	12	12	50	81
		630	724	520	403	4	375	690	434	580	630	10	400	12	12	50	96
		630	724	625	440	4	375	690	529	580	630	10	400	12	12	50	234
71JM	CT9 F2249 DF132	710	804	375	443	3	415	770	259	660	710	10	440	16	12	50	54
		710	804	520	443	3	415	770	404	660	710	10	440	16	12	50	85
		710	804	520	480	4	415	770	404	660	710	10	440	16	12	50	147
80JM	F2249 D132 DF132	800	894	520	488	3	485	860	404	750	800	10	510	16	12	50	94
		800	894	520	525	5	485	860	404	750	800	10	510	16	12	50	163
		800	894	520	525	5	485	860	404	750	800	10	510	16	12	50	194
90JM	F2245 D132 DF160	900	1006	520	538	3	491	970	444	850	900	10	518	16	15	50	88
		900	1006	520	575	5	491	970	444	850	900	12	518	16	15	50	183
		900	1006	625	575	5	491	970	549	850	900	12	518	16	15	50	280
100JM	F2249 D160 DF160	1000	1106	520	588	3	547	1070	444	950	1000	10	574	16	15	50	107
		1000	1106	625	625	5	547	1070	539	950	1000	12	574	16	15	50	268
		1000	1106	625	625	5	547	1070	549	950	1000	12	574	16	15	50	317
48J	D160/LBK D200/57 W200/LF	1219	1357	711	753	5	-	1289	574	1143	1219	14	737	20	18	86	287
		1219	1357	914	753	6	-	1289	777	1143	1219	14	737	20	18	86	562
		1219	1357	813	753	6	-	1289	674	1143	1219	14	737	20	18	86	638
60J	W200/LF W200/LF	1524	1694	813	910	6	-	1626	674	1422	1524	14	921	12	18	87	676
		1524	1694	914	910	6	-	1626	775	1422	1524	14	921	12	18	87	904
75J 1/2	W200/LF	please enquire															

Note : For vertical mounting details of 48J and 60J - please enquire
For 'S' type dimensions, please enquire